



dentoflex.inp
sistema de implantes

CATÁLOGO DE PRODUTOS
2023

M u d a n ç a
Requer
Criatividade e
Coragem para
Traçar um caminho
que **ninguém**
Traçou antes.

dentoflex.inp
sistema de implantes

Desde 1977 construindo história!

Pioneirismo, inovação, e respeito aos nossos clientes e parceiros. Esses atributos compõem o perfil da Dentoflex, uma das empresas na área de saúde odontológica com tradição e reconhecimento no mercado brasileiro.

Utilizando máquinas e equipamentos de última geração para a produção de implantes, instrumentais cirúrgicos e componentes protéticos necessários para o desenvolvimento do trabalho do Implantodontista, nós estabelecemos um rígido e confiável controle de qualidade garantindo simplicidade de uso, economia e ótimos resultados.

O QUE ERA BOM FICOU AINDA MELHOR

Recentemente concluímos um importante ciclo de investimento em conjunto ao Sistema INP, o que permitiu uma sinergia entre as empresas, garantiu a colaboração e o crescimento do parque tecnológico, além de uma produção mais eficiente, a melhoria contínua para o desenvolvimento de novos produtos, novas tecnologias, qualidade e capacitação da engenharia para executar projetos cada vez mais ousados e inovadores. Tudo em sintonia com os desejos e as aspirações dos nossos clientes.

NOSSO PROPÓSITO

Temos paixão na área da saúde, trabalhamos para construir a melhor experiência para dentistas. Buscamos fazer simples e bem feito, de forma ágil e com foco no resultado. E também sempre acompanhados da inovação, característica fundamental para seguirmos criando produtos com precisão, design admirado e de fácil manuseio.



Controle de Qualidade

Com grande foco clínico, nossos produtos primam pela simplicidade de uso, economia e ótimos resultados, isso sem deixar de lado os aspectos científicos, da implantodontia baseada em evidências, começando desde o desenvolvimento de nossa exclusiva superfície de contato.

Nossos implantes são tratados por jateamento mecânico seguido de duplo ataque ácido conferindo uma superfície de grande adesão celular e 100% biocompatível e osseointegrável. Tudo isso em sala controlada certificada ISO Classe 7 e 5.

O Sistema Dentoflex é preocupado com a qualidade de seus produtos, na capacitação de seus colaboradores e no aprimoramento de processos e produtos garantindo assim soluções para nossos clientes.

Contamos com um setor dedicado à qualidade dos produtos, trabalhando sob as restritas normas de qualidades internacionais e nacionais, sendo todos nossos produtos certificados pela BPF – Boas Práticas de Fabricação/ANVISA.



TRATAMENTO DE SUPERFÍCIE

Uma das superfícies de implantes mais utilizadas e consagradas no mercado da Implantodontia.

Jateamento de óxido de titânio, seguindo passivação ácida, combina textura e porosidade ideais para um efeito biológico excelente.

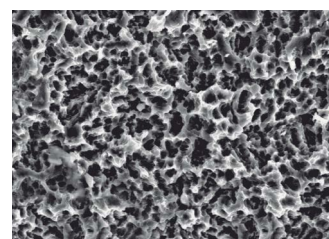
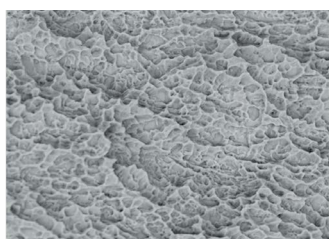
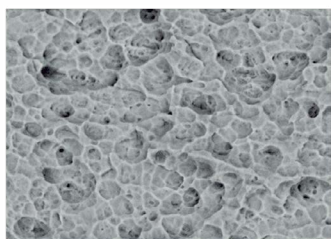

Superfície Híbrida (sanblasted + acid-etched), jateamento (macro porosidade) tratamento com duplo ataque ácido (micro porosidade).

Disponibilizamos acesso a dois arquivos científicos relacionados a Superfície, confira:

- *Considerações sobre limpeza de superfícies de implantes dentários jateados*
- *Implantes de titânio, com superfície rugosa por jateamento. Considerações clínicas e histológicas*



Escaneie o QR Code para acessar os arquivos

*Ressaltamos que todas as imagens deste catálogo são meramente ilustrativas. As tonalidades das cores das peças podem variar.

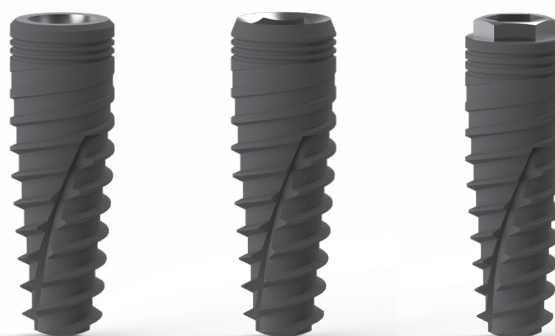

Supreme



O MAIS RECOMENDADO PELOS ESPECIALISTAS

A conexão morse veio como uma evolução aos implantes HE e HI, que são usados até hoje. Superior quanto à adaptação da parte protética, com um encaixe perfeito da interface. Tem vantagens, não somente o selamento biológico da conexão, mas também biomecanicamente e esteticamente, e apresenta maior dinamismo nos procedimentos.

CARACTERÍSTICAS:

Produzido em Titânio ASTM F67 Grau IV
Corpo cônico, rosca dupla
Apresenta cone de 11,5° e rosca 1,8 mm
Plataforma Switch
Alta estabilidade inicial

Indicado para colocação na profundidade de 1, 2 e 3mm
Não acompanha tampa implante
Recomendado para osso tipo I, II, III e IV. *Verificar sequência de brocas.



CHAVES DE CAPTURA E INSTALAÇÃO DO IMPLANTE



Disponível nos tamanhos
Curto e Longo

Descrição	Código
Chave Catraca Curta	55882
Chave Catraca Longa	55883
Chave C.A Curta	55834

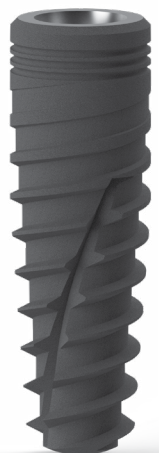

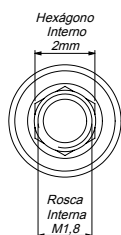
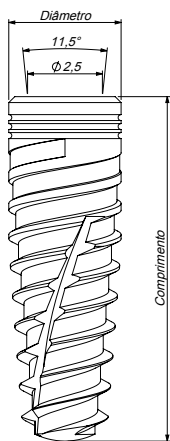

Diâmetro

Comprimentos

Ø 3,50	8,50 mm 56823	10,0 mm 56819	11,5 mm 56820	13,0 mm 56821	15,0 mm 56822
Ø 3,75	8,50 mm 56828	10,0 mm 56824	11,5 mm 56825	13,0 mm 56826	15,0 mm 56827
Ø 4,25	8,50 mm 56833	10,0 mm 56829	11,5 mm 56830	13,0 mm 56831	15,0 mm 56832
Ø 5,00	8,50 mm 56838	10,0 mm 56834	11,5 mm 56835	13,0 mm 56836	15,0 mm 56837

Sequência de Brocas

Implante	Lança	Supreme 3,5	Piloto Supreme 2,8 / 3,5	Supreme 3,75	Piloto Supreme 3,0 / 3,75	Supreme 4,30	Piloto Supreme 3,60 / 4,30	Supreme 5,00	Piloto Supreme 4,30 / 5,00
3,50 mm	●	●	○						
3,75 mm	●	●		●	○				
4,25 mm	●	●		●		●	○		
5,00 mm	●	●		●		●		●	○

○ Para osso tipo I e II

● Para osso tipo III e IV

TAPA IMPLANTE



0,0 mm

56842



1,0 mm

56839



2,0 mm

56840



3,0 mm

56841

CICATRIZADORES



Ø 3,30mm

0,8 mm	56152
1,5 mm	56153
2,5 mm	56154
3,5 mm	56155
4,5 mm	56253
5,5 mm	56254



Ø 4,50mm

0,8 mm	56256
1,5 mm	56257
2,5 mm	56258
3,5 mm	56259
4,5 mm	56260
5,5 mm	56261

TRANSFER MOLDEIRA ABERTA



57940

- ✓ Modelo único com index
- ✓ Produzido em Aço Inox

TRANSFER MOLDEIRA FECHADA



57864

- ✓ Modelo único com index
- ✓ Produzido em Aço Inox

ANÁLOGO DO IMPLANTE



56116

- ✓ Produzido em Aço Inox

**COMBINAÇÃO ENTRE DESIGN E SUPERFÍCIE
MACROGEOMETRIA GARANTE ALTA PRECISÃO E PRATICIDADE**

MUNHÃO UNIVERSAL CONE MORSE



20
N.cm



- ✓ Disponível com e sem index
- ✓ Produzido em Titânio

MUNHÃO UNIVERSAL - SEM Index

Ø 3,30	4,0 mm	0,8 mm	58047
	4,0 mm	1,5 mm	58048
	4,0 mm	2,5 mm	58049
	4,0 mm	3,5 mm	58050
	4,0 mm	4,5 mm	58051
	4,0 mm	5,5 mm	58052
	6,0 mm	0,8 mm	58054
	6,0 mm	1,5 mm	58055
	6,0 mm	2,5 mm	58056
	6,0 mm	3,5 mm	58057
	6,0 mm	4,5 mm	58058
	6,0 mm	5,5 mm	58059
Ø 4,50	4,0 mm	0,8 mm	58061
	4,0 mm	1,5 mm	58095
	4,0 mm	2,5 mm	58096
	4,0 mm	3,5 mm	58097
	4,0 mm	4,5 mm	58098
	4,0 mm	5,5 mm	58099
	6,0 mm	0,8 mm	58101
	6,0 mm	1,5 mm	58102
	6,0 mm	2,5 mm	58103
	6,0 mm	3,5 mm	58104
	6,0 mm	4,5 mm	58105
	6,0 mm	5,5 mm	58106

MUNHÃO UNIVERSAL - COM Index

Ø 3,30	4,0 mm	0,8 mm	58108
	4,0 mm	1,5 mm	58109
	4,0 mm	2,5 mm	58110
	4,0 mm	3,5 mm	58111
	4,0 mm	4,5 mm	58112
	4,0 mm	5,5 mm	58113
	6,0 mm	0,8 mm	58114
	6,0 mm	1,5 mm	58115
	6,0 mm	2,5 mm	58116
	6,0 mm	3,5 mm	58117
	6,0 mm	4,5 mm	58118
	6,0 mm	5,5 mm	58119
Ø 4,50	4,0 mm	0,8 mm	58120
	4,0 mm	1,5 mm	58121
	4,0 mm	2,5 mm	58122
	4,0 mm	3,5 mm	58123
	4,0 mm	4,5 mm	58124
	4,0 mm	5,5 mm	58125
	6,0 mm	0,8 mm	58126
	6,0 mm	1,5 mm	58127
	6,0 mm	2,5 mm	58149
	6,0 mm	3,5 mm	58150
	6,0 mm	4,5 mm	58151
	6,0 mm	5,5 mm	58152

MUNHÃO UNIVERSAL ANGULADO - COM Index



20
N.cm



- ✓ Disponível com index
- ✓ Produzido em Titânio

Ø 3,30	4,0 mm	17°	1,5 mm	56200
	4,0 mm	17°	2,5 mm	56203
	4,0 mm	17°	3,5 mm	56206
	4,0 mm	30°	1,5 mm	56202
	4,0 mm	30°	2,5 mm	56205
	4,0 mm	30°	3,5 mm	56208
	6,0 mm	17°	1,5 mm	56209
	6,0 mm	17°	2,5 mm	56212
	6,0 mm	17°	3,5 mm	56215
	6,0 mm	30°	1,5 mm	56211
	6,0 mm	30°	2,5 mm	56214
	6,0 mm	30°	3,5 mm	56217

Ø 4,50	4,0 mm	17°	1,5 mm	56218
	4,0 mm	17°	2,5 mm	57108
	4,0 mm	17°	3,5 mm	57111
	4,0 mm	30°	1,5 mm	56319
	4,0 mm	30°	2,5 mm	57110
	4,0 mm	30°	3,5 mm	57113
	6,0 mm	17°	1,5 mm	57114
	6,0 mm	17°	2,5 mm	57117
	6,0 mm	17°	3,5 mm	57120
	6,0 mm	30°	1,5 mm	57116
	6,0 mm	30°	2,5 mm	57119
	6,0 mm	30°	3,5 mm	57122

ANÁLOGO DO MUNHÃO UNIVERSAL



Ø 3,30	4,0 mm	56112
	6,0 mm	56113
Ø 4,50	4,0 mm	56114
	6,0 mm	56115

TRANSFER DO MUNHÃO UNIVERSAL

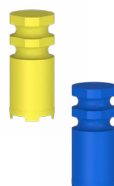

Ø 3,30	4,0 mm	Amarelo	57960
	6,0 mm	Azul	57961
Ø 4,50	4,0 mm	Amarelo	57962
	6,0 mm	Azul	57996

COIFA DO MUNHÃO UNIVERSAL

Calcinável
Antirrotacional



Temporária
Antirrotacional

Ø 3,30	4,0 mm	57173
	6,0 mm	57141
Ø 4,50	4,0 mm	57142
	6,0 mm	57143

Ø 3,30	4,0 mm	57144
	6,0 mm	57145
Ø 4,50	4,0 mm	57146
	6,0 mm	57147

UCLA CINTA METÁLICA CONE MORSE



0,8 mm	58028
1,5 mm	58063
2,5 mm	58065
3,5 mm	58067
4,5 mm	58069

✓ Cinta produzida em Cr-Co

MUNHÃO PROVISÓRIO CONE MORSE



0,8 mm	58180
1,5 mm	58181
2,5 mm	58182
3,5 mm	58183
4,5 mm	58184

✓ Produzido em Titânio

PILAR FLEX CONE MORSE



CINTA	CÓDIGOS
0,8 mm	57383
1,5 mm	57384
2,5 mm	57385
3,5 mm	57386
4,5 mm	57387
5,5 mm	57388

- ✓ Produzido em titânio
- ✓ Rosca de 2,0mm maior resistência
- ✓ Distância oclusal mínima: 6,5mm
- ✓ Parafusada unitária e múltipla

CAPA DE PROTEÇÃO



56151

- ✓ Modelo único
- ✓ Produzido em Titânio

ANÁLOGO



AR

56096

- ✓ Produzido em Aço Inox

TRANSFER MOLDEIRA ABERTA



57952

- ✓ Produzido em Aço Inox

TRANSFER MOLDEIRA FECHADA



59550

- ✓ Produzido em Aço Inox

LUVA METÁLICA



AR	57396
Circular	57398

- ✓ Disponível AR e Circular
- ✓ Produzido em Titânio

LUVA PLÁSTICA



AR	57389
Circular	57393

- ✓ Disponível AR e Circular
- ✓ Produzido em Poliacetal

LUVA CINTA METÁLICA



AR	57391
Circular	57394

- ✓ Disponível AR e Circular
- ✓ Cinta produzida em Cr-Co

OVERDENTURE / SISTEMA O'RING



20 N.cm

2,5

CINTA CÓDIGOS

CINTA	CÓDIGOS
0,8 mm	58344
1,5 mm	58345
2,5 mm	58346
3,5 mm	58347
4,5 mm	58348
5,5 mm	58349

- ✓ Acompanha cápsula de titânio e arruela espaçadora
- ✓ Produzido em Titânio

O'RING FUNDÍVEL



- ✓ Utilizado em raiz natural ou em posição distal da barra-clip
- ✓ Acompanha cápsula de titânio e arruela espaçadora
- ✓ Produzido em Poliacetal

58350



CÁPSULA METÁLICA

58279

- ✓ Produzido em Titânio



ARRUELA ESPAÇADORA

55341

- ✓ Produzido em Poliacetal
- c/10 unidades



ANEL O'RING 10 und.

56227

- ✓ Produzido em Borracha

CONJUNTO BARRA CLIP

59246	BARRA
56660	CLIP 35°
56661	CLIP 70°
56662	CLIP RETO

- ✓ Indicado para uso em Implantes com distância mínima de 22 mm
- ✓ Produzido em Poliacetal

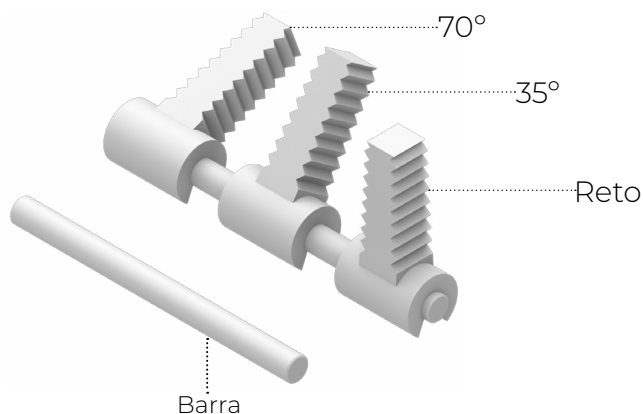

MIRUSCONE ANGULADO CONE MORSE



1,5 mm	17°	57925
2,5 mm	17°	57928
3,5 mm	17°	57964
1,5 mm	30°	57927
2,5 mm	30°	57963
3,5 mm	30°	57966

- ✓ Produzido em Titânio
- ✓ Com Index
- ✓ Com parafuso passante
- ✓ Não deve ser usado para unitário
- ✓ Com transportador metálico
- ✓ Indicado para prótese Multipla e Total

MIRUSCONE RETO CONE MORSE



0,8 mm	57910
1,5 mm	57911
2,5 mm	57915
3,5 mm	57919
4,5 mm	57923
5,5 mm	57924

- ✓ Produzido em Titânio
- ✓ Distância oclusal mínima: 4,5mm
- ✓ Não deve ser usado para unitário
- ✓ Com transportador plástico
- ✓ Indicado para prótese Multipla e Total

CAPA DE PROTEÇÃO PARA MIRUSCONE



53944

- ✓ Modelo único
- ✓ Produzido em Titânio

ANÁLOGO



56111

- ✓ Modelo único
- ✓ Produzido em Aço Inox

TRANSFER MOLDEIRA ABERTA



57959

- ✓ Modelo único
- ✓ Produzido em Aço Inox

TRANSFER MOLDEIRA FECHADA



58575

- ✓ Modelo único
- ✓ Produzido em Aço Inox

LUVA METÁLICA



57903

- ✓ Modelo único
- ✓ Produzido em Titânio

LUVA CINTA METÁLICA



57907

- ✓ Modelo único
- ✓ Cinta produzida em Cr-Co

LUVA PLÁSTICA



55343

- ✓ Modelo único
- ✓ Produzido em Poliacetal

Supreme

Hexágono Interno

O IMPLANTE MAIS VENDIDO

Corpo cônico os implantes hexágono interno conseguem alcançar uma boa estabilidade primária e são compatíveis com todos os tipos ósseos, mesmo em casos de osso não compactado. Pode ser utilizado em qualquer tipo de restauração protética, aparafusada e cimentada.

CARACTERÍSTICAS:

Produzido em Titânio ASTM F67 Grau IV

Corpo cônico, rosca dupla

Plataforma Switch

Hexágono Interno 2,50 mm

Rosca interna de 2,00 mm

Alta estabilidade inicial

Acompanha tampa implante

Recomendado para osso tipo I, II, III e IV. *Verificar sequência de brocas.

CHAVE DE CAPTURA E INSTALAÇÃO



Disponível nos tamanhos
Curto e Longo

Chaves para captura do
Implante, finalização deverá ser
com intermediário para catraca.

Descrição	Código
Intermediário Catraca Curta	57755
Intermediário Catraca Longa	57756
Chave C.A Curta	57753

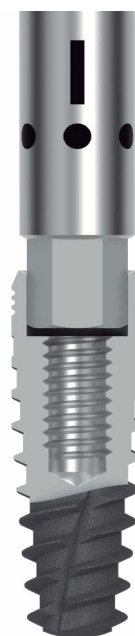

Diâmetro

Comprimentos

Ø 3,50	8,50 mm 56955	10,0 mm 56951	11,5 mm 56952	13,0 mm 56953	15,0 mm 56954
Ø 3,75	8,50 mm 56960	10,0 mm 56956	11,5 mm 56957	13,0 mm 56958	15,0 mm 56959
Ø 4,25	8,50 mm 56965	10,0 mm 56961	11,5 mm 56962	13,0 mm 56963	15,0 mm 56964
Ø 5,00	8,50 mm 56970	10,0 mm 56966	11,5 mm 56967	13,0 mm 56968	15,0 mm 56969

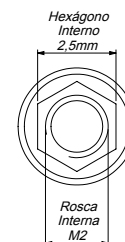
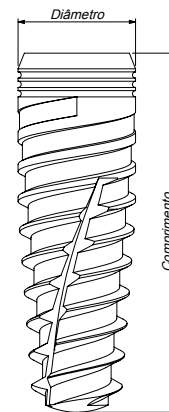

Sequência de Brocas

Switch	Implante	Lança	Supreme 3,5	Piloto Supreme 2,8 / 3,5	Supreme 3,75	Piloto Supreme 3,0 / 3,75	Supreme 4,30	Piloto Supreme 3,60 / 4,30	Supreme 5,00	Piloto Supreme 4,30 / 5,00
3,25 mm	3,50 mm	●	●	○						
3,25 mm	3,75 mm	●	●		●	○				
3,75 mm	4,25 mm	●	●		●		●	○		
4,25 mm	5,00 mm	●	●		●		●		●	○

○ Para osso tipo I e II

● Para osso tipo III e IV

CICATRIZADORES



3,25 mm	3,0 mm	57809
	5,0 mm	57810
	7,0 mm	57811
3,75 mm	3,0 mm	57816
	5,0 mm	57817
	7,0 mm	57818
4,25 mm	3,0 mm	57822
	5,0 mm	57823
	7,0 mm	57824

3,25 mm	3,0 mm	5,0 mm	55994
	5,0 mm	5,0 mm	55997
3,75 mm	3,0 mm	5,0 mm	56012
	5,0 mm	5,0 mm	56015
4,25 mm	3,0 mm	5,0 mm	56128
	5,0 mm	5,0 mm	56131

ANÁLOGO DO IMPLANTE



Ø 3,25	56103
Ø 3,75	56105
Ø 4,25	56107

✓ Produzido em Aço Inox

TRANSFER MOLDEIRA ABERTA



57938

- ✓ Modelo único para todos os diâmetros
- ✓ Altura única
- ✓ Produzido em Aço Inox

TRANSFER MOLDEIRA FECHADA



58569

- ✓ Altura única
- ✓ Produzido em Aço Inox

UCLA CINTA METÁLICA AR E CIRCULAR



1,3

AR CIRCULAR

	AR	CIRCULAR
Ø 3,25	58132	58087
Ø 3,75	58134	58089
Ø 4,25	58136	58091

- ✓ Disponível em três diâmetros
- ✓ Altura única
- ✓ Cinta produzida em Cr-Co

UCLA PLÁSTICA AR E CIRCULAR



1,3

AR CIRCULAR

	AR	CIRCULAR
Ø 3,25	58007	58019
Ø 3,75	58009	55303
Ø 4,25	58011	58023

- ✓ Disponível em três diâmetros
- ✓ Altura única
- ✓ Produzido em Poliacetal

MUNHÃO ANGULADO



- ✓ Disponível em três diâmetros
- ✓ Produzido em Titânio

Ø 3,25	1,0 mm	15°	56465
	2,0 mm	15°	56467
	3,0 mm	15°	56469
	1,0 mm	25°	56473
	2,0 mm	25°	56475
	3,0 mm	25°	56477
	1,0 mm	35°	56480
	2,0 mm	35°	56482
	3,0 mm	35°	56846
Ø 3,75	1,0 mm	15°	56865
	2,0 mm	15°	56867
	3,0 mm	15°	56869
	1,0 mm	25°	56872
	2,0 mm	25°	56874
	3,0 mm	25°	56876
	1,0 mm	35°	57240
	2,0 mm	35°	57242
	3,0 mm	35°	57244
Ø 4,25	1,0 mm	15°	57257
	2,0 mm	15°	57259
	3,0 mm	15°	57260
	1,0 mm	25°	57262
	2,0 mm	25°	57264
	3,0 mm	25°	57265
	1,0 mm	35°	57267
	2,0 mm	35°	57269
	3,0 mm	35°	57271

MUNHÃO TEMPORÁRIO CIRCULAR



- ✓ Disponível em três diâmetros
- ✓ Altura única
- ✓ Produzido em Titânio

Ø 3,25	58260
Ø 3,75	58262
Ø 4,25	58264

MUNHÃO PARA PRÓTESE CIMENTADA



- ✓ Disponível em três diâmetros
- ✓ Produzido em Titânio

Ø 3,25	1,0 mm	56588
	2,0 mm	56589
	3,0 mm	56590
Ø 3,75	1,0 mm	56597
	2,0 mm	56598
	3,0 mm	56599
Ø 4,25	1,0 mm	56606
	2,0 mm	56607
	3,0 mm	56608

MUNHÃO TEMPORÁRIO AR



Ø 3,25	58249
Ø 3,75	58251
Ø 4,25	58253

- ✓ Disponível em três diâmetros
- ✓ Altura única
- ✓ Produzido em Titânio

MIRUSCONE ANGULADO

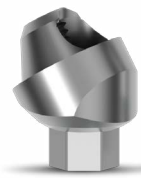

20
N.cm



- ✓ Produzido em Titânio
- ✓ Disponível em dois tamanhos
- ✓ Distância oclusal mínima: 4,5mm
- ✓ Com transportador metálico
- ✓ Indicado para prótese Múltipla e Total

Ø 3,25	1,0 mm	17°	56333
	2,0 mm	17°	56334
	3,0 mm	17°	56336
	1,0 mm	30°	56345
	2,0 mm	30°	56347
	3,0 mm	30°	56349
Ø 3,75	1,0 mm	17°	56725
	2,0 mm	17°	56727
	3,0 mm	17°	56729
	1,0 mm	30°	56739
	2,0 mm	30°	56741
	3,0 mm	30°	56743

MIRUSCONE RETO



32
N.cm



- ✓ Produzido em Titânio
- ✓ Distância oclusal mínima: 4,5mm
- ✓ Não deve ser usado para unitário
- ✓ Com transportador plástico
- ✓ Indicado para prótese múltipla e total

Ø 3,25	1,0 mm	56331
	2,0 mm	56337
	3,0 mm	56343
Ø 3,75	1,0 mm	56723
	2,0 mm	56730
	3,0 mm	56737
Ø 4,25	1,0 mm	58512
	2,0 mm	58513
	3,0 mm	58514

CAPA DE PROTEÇÃO PARA MIRUSCONE



53944

- ✓ Modelo único
- ✓ Produzido em Titânio

ANÁLOGO



56111

- ✓ Modelo único
- ✓ Produzido em Aço Inox

TRANSFER MOLDEIRA ABERTA



57959

- ✓ Modelo único
- ✓ Produzido em Aço Inox

TRANSFER MOLDEIRA FECHADA



58575

- ✓ Modelo único
- ✓ Produzido em Aço Inox

LUVA METÁLICA



57903

- ✓ Modelo único
- ✓ Produzido em Titânio

LUVA CINTA METÁLICA



57907

- ✓ Modelo único
- ✓ Cinta produzida em Cr-Co

LUVA PLÁSTICA



55343

- ✓ Modelo único
- ✓ Produzido em Poliacetal

OVERDENTURE



Ø 3,25	1,0 mm	58297
	2,0 mm	58298
	3,0 mm	58299
	4,0 mm	58300
	5,0 mm	58301
Ø 3,75	1,0 mm	58309
	2,0 mm	58311
	3,0 mm	58312
	4,0 mm	58313
Ø 4,25	5,0 mm	58314
	1,0 mm	58322
	2,0 mm	58323
	3,0 mm	58324
	4,0 mm	58325
	5,0 mm	58326

- ✓ Acompanha cápsula de titânio e arruela espaçadora
- ✓ Produzido em Titânio

O'RING FUNDÍVEL



- ✓ Utilizado em raiz natural ou em posição distal da barra-clip
- ✓ Acompanha cápsula de titânio e arruela espaçadora
- ✓ Produzido em Poliacetal

58350



CÁPSULA METÁLICA

58279

- ✓ Produzido em Titânio



ARRUELA ESPAÇADORA

55341

- ✓ Produzido em Poliacetal
- c/10 unidades



ANEL O'RING 10 und.

56227

- ✓ Produzido em Borracha

CONJUNTO BARRA CLIP

59246	BARRA
56660	CLIP 35°
56661	CLIP 70°
56662	CLIP RETO

- ✓ Indicado para uso em Implantes com distância mínima de 22 mm

- ✓ Produzido em Poliacetal

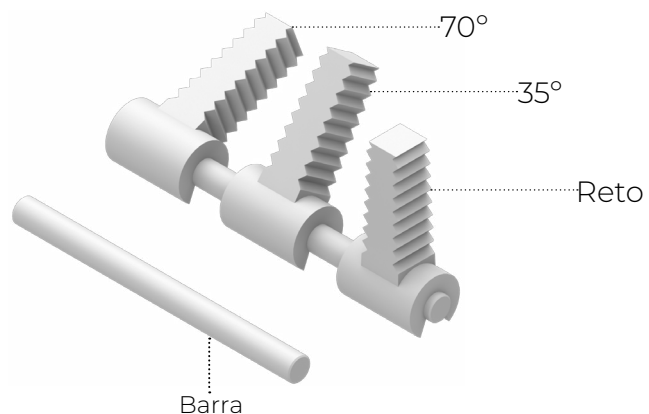

Supreme

Hexágono Externo

UMA BOA ALTERNATIVA PARA REABILITAÇÃO DENTÁRIA

Os implantes hexágono externo atendem todos os tipos de reabilitações protéticas, sendo possível ser feito com carga imediata ou precoce. Seu sistema abrange uma grande variedade de componentes protéticos o que facilita a escolha da solução adequada para cada paciente.

CARACTERÍSTICAS:

Produzido em Titânio ASTM F67 Grau IV

Corpo cônico, rosca dupla

Plataforma Switch

Hexágono Externo 2,70 mm

Altura do hexágono 0,70 mm

Rosca interna de 2,00 mm

Alta estabilidade inicial

Acompanha tampa implante

Recomendado para osso tipo I, II, III e IV. *Verificar sequência de brocas.

Torque Interno

CHAVES DE CAPTURA E INSTALAÇÃO DO IMPLANTE



Disponível nos tamanhos Curto e Longo

Chaves para captura do Implante, finalização deverá ser com intermediário para catraca.

Descrição	Código
Chave Catraca Curta	55882
Chave Catraca Longa	55883
Chave C.A Curta	55851

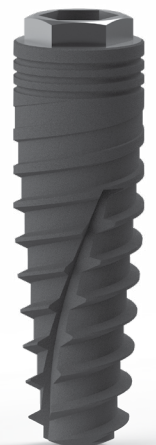
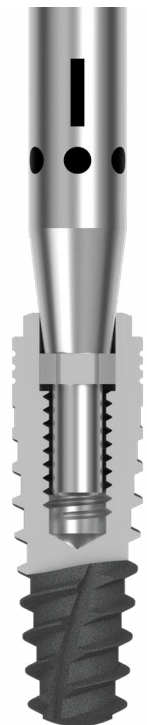

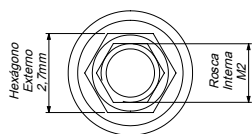
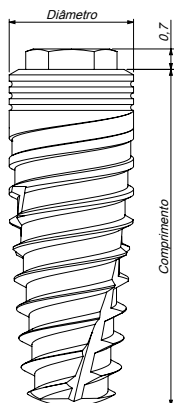

Diâmetro

Comprimentos

Ø 3,75	8,50 mm 57079	10,0 mm 57075	11,5 mm 57076	13,0 mm 57077	15,0 mm 57078
Ø 4,25	8,50 mm 57084	10,0 mm 57080	11,5 mm 57081	13,0 mm 57082	15,0 mm 57083
Ø 5,00	8,50 mm 57089	10,0 mm 57085	11,5 mm 57086	13,0 mm 57087	15,0 mm 57088

Sequência de Brocas

Implante	Lança	Supreme 3,5	Piloto Supreme 2,8 / 3,5	Supreme 3,75	Piloto Supreme 3,0 / 3,75	Supreme 4,30	Piloto Supreme 3,60 / 4,30	Supreme 5,00	Piloto Supreme 4,30 / 5,00
3,75 mm	●	●		●	○				
4,25 mm	●	●		●		●	○		
5,00 mm	●	●		●		●		●	○

○ Para osso tipo I e II

● Para osso tipo III e IV

CICATRIZADORES



07635	CICATRIZADOR W 4,1 X 3,0 X 5,4
01280	CICATRIZADOR W 4,1 X 4,0 X 5,4
07638	CICATRIZADOR W 4,1 X 6,0 X 5,4

07518	CICATRIZADOR PARALELO 4,1 X 3,0
07519	CICATRIZADOR PARALELO 4,1 X 4,0
07521	CICATRIZADOR PARALELO 4,1 X 6,0

TRANSFER MOLDEIRA ABERTA



1,2

55345

- ✓ Modelo único para todos os diâmetros
- ✓ Produzido em Aço Inox

TRANSFER MOLDEIRA FECHADA



1,2

58565

- ✓ Modelo único para todos os diâmetros
- ✓ Produzido em Aço Inox

ANÁLOGO DO IMPLANTE



Ø 3,75

56100

- ✓ Produzido em Aço Inox

UCLA CINTA METÁLICA AR E CIRCULAR



32
N.cm

1,3

	AR	CIRCULAR
Ø 3,75	58129	58084

- ✓ Altura única
- ✓ Cinta produzida em Cr-Co

UCLA PLÁSTICA AR E CIRCULAR



32
N.cm

1,3

	AR	CIRCULAR
Ø 3,75	58003	58016

- ✓ Altura única
- ✓ Produzido em Poliacetal

MUNHÃO ANGULADO



Ø 3,75	1,0 mm	15°	56451
	2,0 mm	15°	56452
	3,0 mm	15°	56453
	1,0 mm	25°	56455
	2,0 mm	25°	56456
	3,0 mm	25°	56457
	1,0 mm	35°	56459
	2,0 mm	35°	56460
	3,0 mm	35°	56461

✓ Produzido em Titânio

MUNHÃO TEMPORÁRIO AR



Ø 3,75	58247
--------	-------

✓ Produzido em Titânio

MUNHÃO TEMPORÁRIO CIRCULAR



Ø 3,75	58258
--------	-------

✓ Produzido em Titânio

MUNHÃO PARA PRÓTESE CIMENTADA



Ø 3,75	1,0 mm	56582
	2,0 mm	56583
	3,0 mm	56584

✓ Produzido em Titânio

MIRUSCONE ANGULADO



Ø 3,75	1,0 mm	17°	57796
	2,0 mm	17°	57797
	3,0 mm	17°	56320
	1,0 mm	30°	56325
	2,0 mm	30°	56326
	3,0 mm	30°	56327

- ✓ Produzido em Titânio
- ✓ Distância oclusal mínima: 4,5mm
- ✓ Com transportador metálico
- ✓ Indicado para prótese múltipla e total

MIRUSCONE RETO



Ø 3,75	1,0 mm	57795
	2,0 mm	56322
	3,0 mm	56324

- ✓ Produzido em Titânio
- ✓ Distância oclusal mínima: 4,5mm
- ✓ Com transportador plástico
- ✓ Indicado para prótese múltipla e total

CAPA DE PROTEÇÃO PARA MIRUSCONE



53944

- ✓ Modelo único
- ✓ Produzido em Titânio

ANÁLOGO



56111

- ✓ Modelo único
- ✓ Produzido em Aço Inox

TRANSFER MOLDEIRA FECHADA



58575

- ✓ Modelo único
- ✓ Produzido em Aço Inox

TRANSFER MOLDEIRA ABERTA



57959

- ✓ Modelo único
- ✓ Produzido em Aço Inox

LUVA METÁLICA



57903

- ✓ Modelo único
- ✓ Produzido em Titânio

LUVA CINTA METÁLICA



57907

- ✓ Modelo único
- ✓ Cinta produzida em Cr-Co

LUVA PLÁSTICA



55343

- ✓ Modelo único
- ✓ Produzido em Poliacetal

OVERDENTURE / SISTEMA O'RING



20
N.cm

2,5

- ✓ Acompanha cápsula de titânio e arruela espaçadora
- ✓ Produzido em Titânio

Ø 3,75	1,0 mm	58287
	2,0 mm	58289
	3,0 mm	58290
	4,0 mm	58292
	5,0 mm	58293

O'RING FUNDÍVEL



- ✓ Utilizado em raiz natural ou em posição distal da barra-clip
- ✓ Acompanha cápsula de titânio e arruela espaçadora
- ✓ Produzido em Poliacetal

58350



CÁPSULA METÁLICA

- ✓ Produzido em Titânio

58279



ARRUELA ESPAÇADORA

- ✓ Produzido em Poliacetal
- c/ 10 unidades

55341



ANEL O'RING 10 und.

- ✓ Produzido em Borracha

56227

CONJUNTO BARRA CLIP

59246	BARRA
56660	CLIP 35°
56661	CLIP 70°
56662	CLIP RETO

- ✓ Indicado para uso em Implantes com distância mínima de 22 mm
- ✓ Produzido em Poliacetal

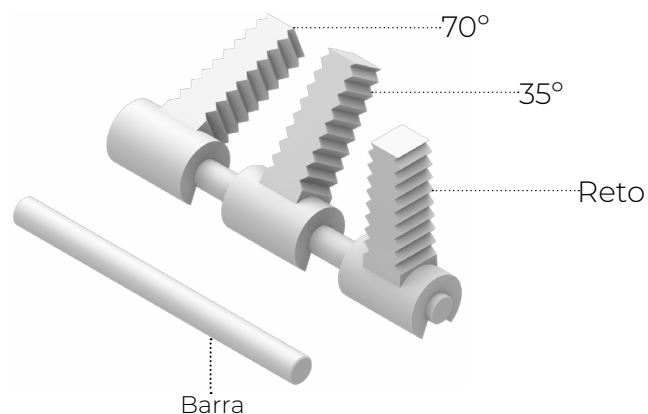

Kit Cirúrgico

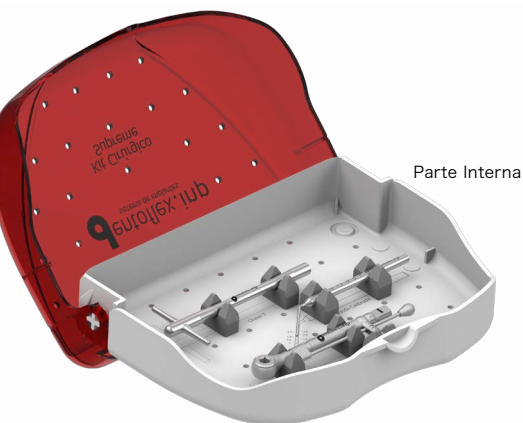
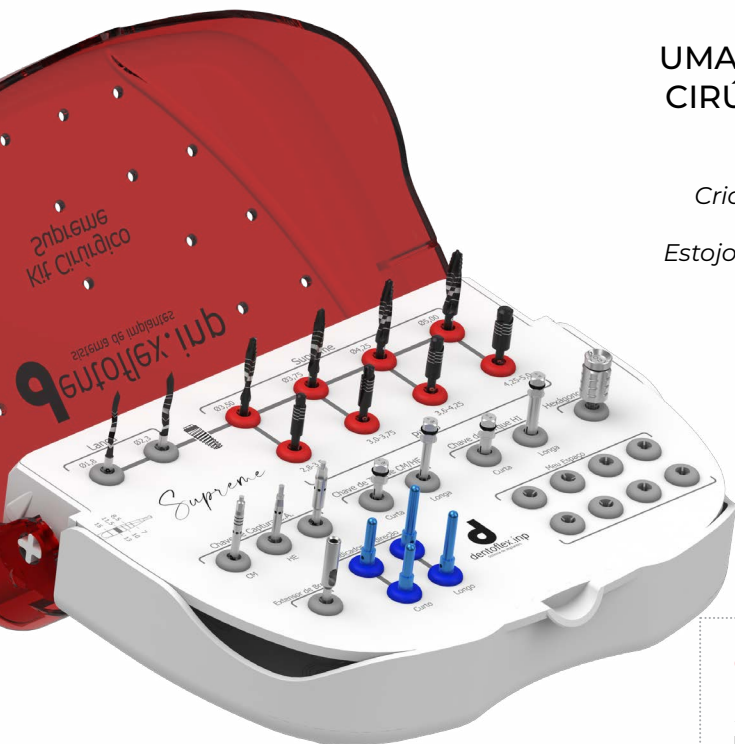

UMA DAS PRINCIPAIS VANTAGENS DO KIT CIRÚRGICO É QUE ELE PODE SER USADO EM TODA A LINHA SUPREME

Criado especialmente para garantir a eficiência na dinâmica do seu consultório. Estejo leve e de fácil manuseio, torna também o kit mais versátil e prático.

55932

KIT CIRÚRGICO

07739

ESTOJO KIT CIRÚRGICO

COMPONENTES

Cod.	Descrição	Qtd.
56767	BROCA LANÇA TRI-HELICOIDAL Ø1,80	1
55750	BROCA LANÇA TRI-HELICOIDAL Ø2,30	1
56880	BROCA PILOTO SUPREME 2,8-3,5	1
55729	BROCA SUPREME Ø3,50	1
56881	BROCA PILOTO SUPREME 3,0-3,75	1
55731	BROCA SUPREME Ø3,75	1
56882	BROCA PILOTO SUPREME 3,6-4,3	1
55738	BROCA SUPREME Ø4,30	1
56883	BROCA PILOTO SUPREME 4,3-5,0	1
56879	BROCA SUPREME Ø5,00	1
55834	CHAVE CURTA P/ IMPL. O.C. C.M. P/ C.A.	1
55882	CHAVE CURTA P/ IMPL. O.C. C.M. P/ CATRACA	1
55851	CHAVE CURTA P/ IMPL. T.I. P/ C.A.	1
08877	CHAVE DE TORQUE	1
01379	CHAVE DIGITAL HEXAGONAL MÉDIA	1
55883	CHAVE LONGA P/ IMPL. O.C. C.M. P/ CATRACA	1
01393	CHAVE T FIXA	1
06821	EXTENSOR DE BROCA	1
57750	INDICAÇÃO DE DIREÇÃO CURTO ACESS. P/ IMPL.	2
57751	INDICADOR DE DIREÇÃO LONGO ACESS. P/ IMPL.	2
57753	INTERMEDIÁRIO CURTO P/ C.A. P/ IMPL. HI	1
57755	INTERMEDIÁRIO P/ CATRACA CURTO P/ IMPL. HI	1
57756	INTERMEDIÁRIO P/ CATRACA LONGO P/ IMPL. HI	1
55832	SONDA CALIBRADA P/ IMPLANTE	1

PARA USO EM TODA

Linha Supreme

CONE MORSE / HE / HI

Kit único e versátil: evite volume, priorize a qualidade, funcionalidade, e a eficiência no seu dia a dia.

Mais eficiência para maximização de resultados

Menos materiais para manusear

Número reduzido de erros ou enganos

Menor ocupação do espaço físico

Mais agilidade nos procedimentos

BROCAS

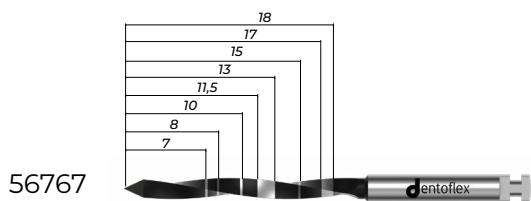

56767

BROCA LANÇA TRI-HELICOIDAL Ø1,80

55750



BROCA LANÇA TRI-HELICOIDAL Ø2,30

56880



BROCA PILOTO SUPREME 2,8-3,5

56881



BROCA PILOTO SUPREME 3,0-3,75

56882

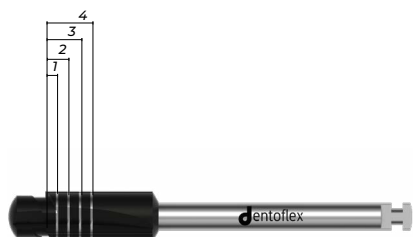

BROCA PILOTO SUPREME 3,6-4,3

56883



BROCA PILOTO SUPREME 4,3-5,0

55729

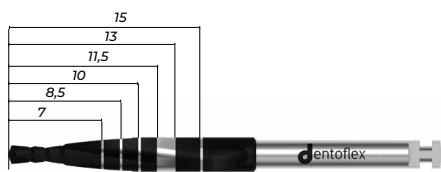

BROCA SUPREME Ø3,50

55731



BROCA SUPREME Ø3,75

55738



BROCA SUPREME Ø4,30

56879



BROCA SUPREME Ø5,00

CHAVES

CHAVES DE CAPTURA

55834



CHAVE PARA IMPL. C.M. PARA CONTRA ÂNGULO

55851



CHAVE PARA IMPL. H.E PARA CONTRA ÂNGULO

57753



CHAVE PARA IMPL. H.I. PARA CONTRA ÂNGULO

CHAVE DE CAPTURA DE CONTRA ÂNGULO,
TORQUE MÁXIMO 35 N.cm

CHAVES DE INSTALAÇÃO

55882



CHAVE CURTA P/ IMPL. O.C. C.M. P/ CATRACA

55883



CHAVE LONGA P/ IMPL. O.C. C.M. P/ CATRACA

57755

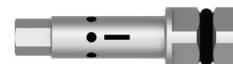

INTERMEDIÁRIO P/ CATRACA CURTO P/ IMPL. HI

57756



INTERMEDIÁRIO P/ CATRACA LONGO P/ IMPL. HI

01379



CHAVE DIGITAL HEXAGONAL MÉDIA

06821



EXTENSOR DE BROCA

INDICADORES

57750



INDICAÇÃO DE DIREÇÃO CURTO

57751



INDICADOR DE DIREÇÃO LONGO

01393

CHAVE T FIXA



55832

SONDA CALIBRADA PARA IMPLANTE

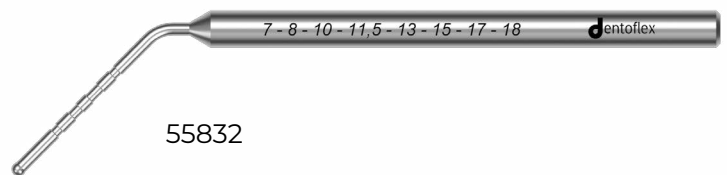

08877

CHAVE DE TORQUE



Supreme Guided



Supreme Guided

CIRURGIA 100% GUIADA INTUITIVO, DESIGN ADMIRADO E PRECISÃO

Integramos soluções de odontologia digital, garantindo simplicidade de uso, economia e ótimos resultados.



- Material Polímero de PPSU: não oxida e não apresenta manchas;
- Autoclaváveis em até 135°C / 275°F;
- Borrachas em silicone e coloridas para identificação das brocas;
- Escalas para verificação da marcação das ferramentas;
- Tampa inclinável serve de apoio da plataforma no momento da abertura;
- Acomodação para a torquímetro para autoclavagem;
- Estojo leve e de fácil manuseio.

60233
ESTOJO KIT CIRURGIA GUIADA

55929
KIT CIRURGIA GUIADA



Broca

Ø 1,3mm



56765

Fixadores de Guia



56666

Estabilizadores de Guia

CM



56664

HI - HE



56665

Punch

Ø 4,3mm



57742

Brocas

Lança

Escalonada

Ø 3,5mm

8,5 10 11,5 13

Ø 3,75mm

8,5 10 11,5 13

Ø 2,8 - 3,5

Ø 3,0 - 3,75



59962



60338



59987



59989



59991



59993



60003



60004

Broca Piloto

Chaves de Captura para C.A.

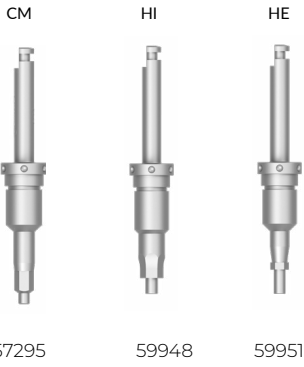

Chaves de Torque



Chaves

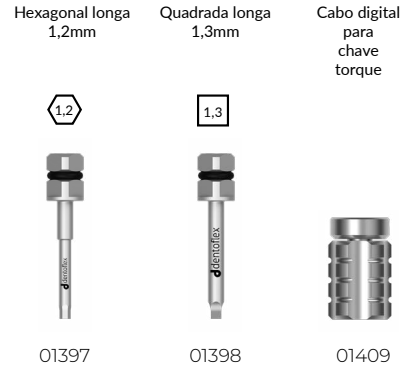

Acessórios



Anilhas



Guias para Fixadores



*Supreme
Guided*

SEQUÊNCIA DE FRESAS

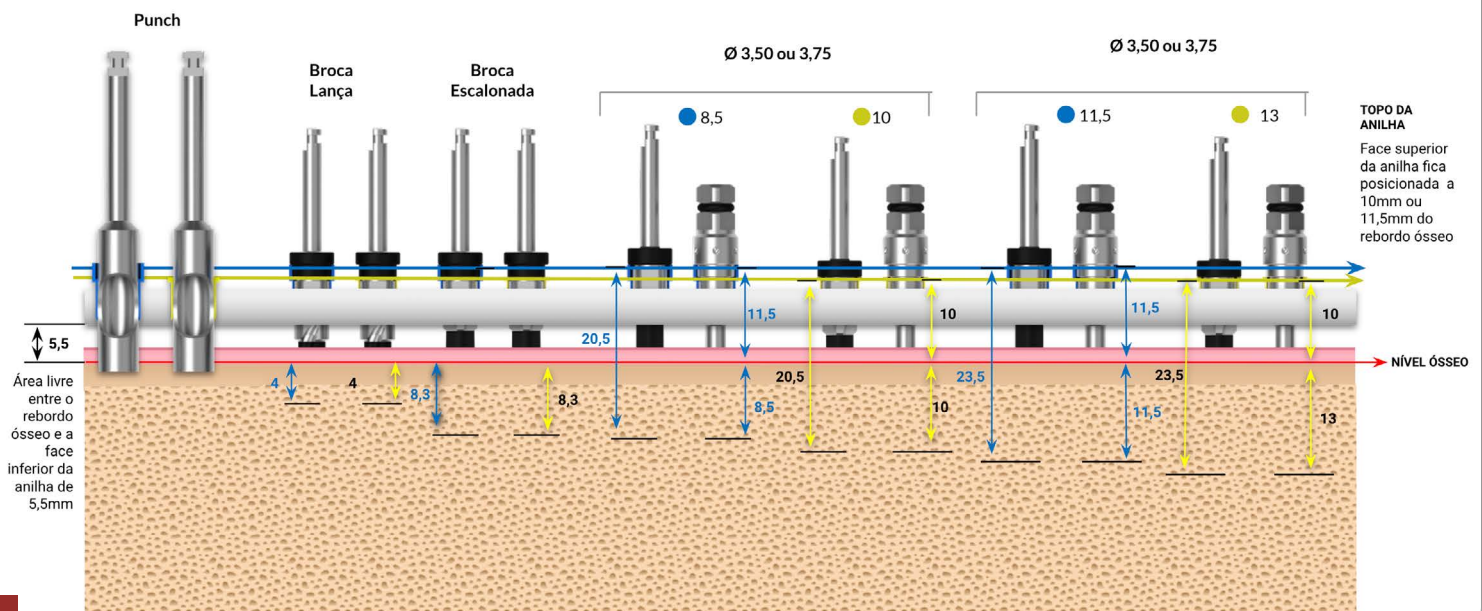

Comuniquemos com o seu paciente de maneira clara e precisa

Com base nas particularidades de cada paciente o planejamento virtual pré-operatório, permitirá que você comunique a esse paciente, sobre como será o tratamento, revelando detalhes do procedimento como: precisão, simplicidade e segurança.



VANTAGENS DA CIRURGIA GUIADA

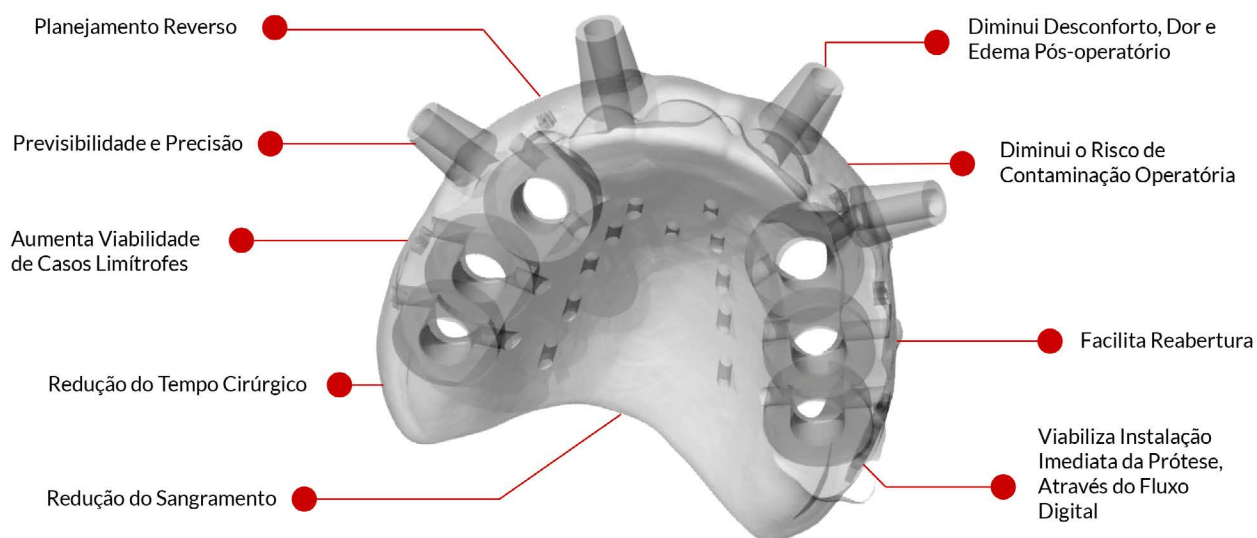

CIRURGIA GUIADA

Planning Center - 3D Print

Fazemos o seu planejamento virtual e guia cirúrgico

Garantimos o suporte necessário para sua clínica do início ao fim.



Passo a passo para solicitação do planejamento e do guia cirúrgico



1 - Radiologia

Paciente é encaminhado pelo dentista ao centro de radiologia para:

Paciente parcialmente Desdentado: Tomo (Dicon) + Scanner (STL)

Paciente Edêntulo: Tomo (Dicon) + Tomo (Dicon) do guia do paciente



2 - Pretensão

Encaminhar para o e-mail: planejamento@dentoflex.com.br uma previsão do caso: indicação dos dentes a serem implantados, plataforma do implante e enviar junto os arquivos recebidos da radiologia.



3 - Planejamento

Fazemos todo o planejamento da cirurgia, com especificação dos implantes em até 3 dias úteis.

4 - Aprovação

Retornaremos o planejamento para o dentista seguir com a aprovação.

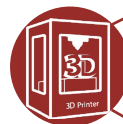

5 - Impressão

Assim que recebemos a aprovação do planejamento, o guia é impresso e despachado em até 2 dias úteis.



6 - Cirurgia

Procedimento cirúrgico, com alta precisão dimensional e encaixe perfeito do guia cirúrgico.

**Cirurgia Guiada como você nunca viu.
Mais simples, impossível!**

Search



SEGURANÇA PARA QUEM TEM MAXILA ATRÓFICA

A linha Search veio com uma evolução aos implantes longos. Criado com base no Cone Morse esse implante pode ser utilizado nas técnicas All-on-four e pterigóideo.

CARACTERÍSTICAS:

Produzido em Titânio ASTM F67

Grau IV

Corpo cônico, rosca dupla

Apresenta cone de 11,5° e rosca

1,8 mm

Plataforma Switch

Alta estabilidade inicial

Indicado para colocação na profundidade de 1, 2 e 3mm

Para posicionamento intraósseo é recomendado adicionar 1 a 2 mm ao comprimento do implante durante a instrumentação cirúrgica

Não acompanha tampa implante

Para osso tipo III e IV

CHAVES DE CAPTURA E INSTALAÇÃO DO IMPLANTE



Disponível nos tamanhos Curto e Longo

Descrição	Código
Chave Catraca Curta	55882
Chave Catraca Longa	55883
Chave C.A Curta	55834

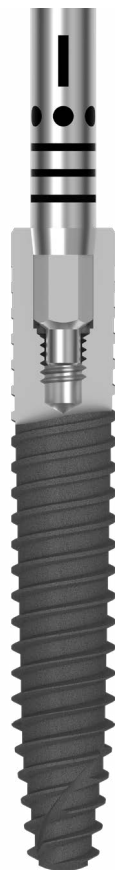

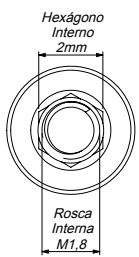
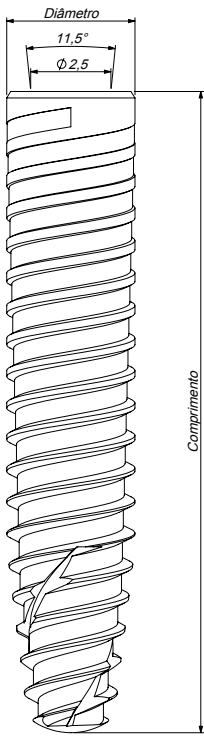

Diâmetro

Comprimentos

$\phi 3,75$	18 mm 59756	20 mm 59757	22,5 mm 59759	25 mm 59761
$\phi 4,00$	18 mm 59762	20 mm 59763	22,5 mm 59765	25 mm 59767

Sequência de Brocas

Implante	Lança (Opcional)	Helicoidal $\phi 2,30$ MM Longa	Supreme $\phi 3,75$ MM Longa	Supreme $\phi 4,00$ MM Longa
3,75 mm	●	●	●	
4,00 mm	●	●	●	●

● Para osso tipo III e IV

TAPA IMPLANTE



0,0 mm

56842



1,0 mm

56839



2,0 mm

56840



3,0 mm

56841

MIRUSCONE ANGULADO



1,5 mm	17°	57925
1,5 mm	30°	57927
1,5 mm	*45°	60110
2,5 mm	17°	57928
2,5 mm	30°	57963
2,5 mm	*45°	60113
3,5 mm	17°	57964
3,5 mm	30°	57966

- ✓ Produzido em Titânio
- ✓ Com Index
- ✓ Com parafuso passante
- ✓ Não deve ser usado para unitário
- ✓ Com transportador metálico
- ✓ Indicado para prótese múltipla e total
- ✓ *Indicação de uso apenas nos implantes Search em protocolo.

MIRUSCONE RETO



0,8 mm	57910
1,5 mm	57911
2,5 mm	57915
3,5 mm	57919
4,5 mm	57923
5,5 mm	57924

- ✓ Produzido em Titânio
- ✓ Distância oclusal mínima: 4,5mm
- ✓ Não deve ser usado para unitário
- ✓ Com transportador plástico
- ✓ Indicado para prótese múltipla e total

Kit Search



Kit único e versátil: evite volume, priorize a qualidade, funcionalidade, e a eficiência no seu dia a dia.

PARA USO NA

Linha Search

GARANTA AGILIDADE E PRATICIDADE AOS PROCEDIMENTOS CIRÚRGICOS

Criado especialmente para garantir a eficiência no dia a dia do seu consultório.

60231

KIT SEARCH

60230

ESTOJO KIT SEARCH

CARACTERÍSTICAS:

Cod.	Descrição	Qtd.
59926	BROCA LANÇA	1
59988	BROCA HELICOIDAL Ø2,30MM LONGA	1
59922	BROCA SUPREME Ø3,75 LONGA	1
60009	BROCA SUPREME Ø4 LONGA	1
59870	EXPANSOR LAMINADOR CÔNICO LONGO Ø2,6	1
59871	EXPANSOR LAMINADOR CÔNICO LONGO Ø2,9	1
59872	EXPANSOR LAMINADOR CÔNICO LONGO Ø3,2	1
59873	EXPANSOR LAMINADOR CÔNICO LONGO Ø3,7	1
55882	CHAVE CURTA IMP. OSSEO COMP CONE MORSE P/ CAT	1
55834	CHAVE CURTA P/ IMP. OSSEO COMP. CONE MORSE P/ C. A.	1
08877	CHAVE DE TORQUE	1
01379	CHAVE DIGITAL HEXAGONAL MÉDIA	1
55883	CHAVE LONGA IMP. OSSEO COMP CONE MORSE P/ CAT	1
01393	CHAVE T FIXA	1
59711	GUIA DE POSICIONAMENTO ALL ON FOUR	1
60088	MEDIDOR DE ANG. 17° E TRANSMUCOSO CM	1
60089	MEDIDOR DE ANG. 30° E TRANSMUCOSO CM	1
60090	MEDIDOR DE ANG. 45° E TRANSMUCOSO CM	1
60084	SONDA CALIBRADA PARA IMPLANTE LONGO	1
01415	CHAVE MONTADORA PARA CONTRA ANGULO	1

BROCAS



BROCA LANÇA



BROCA HELICOIDAL Ø2,30MM LONGA



BROCA SUPREME Ø3,75 LONGA



BROCA SUPREME Ø4,00 LONGA

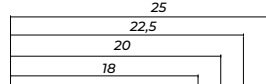

CHAVES

CHAVES DE CAPTURA



CHAVE PARA IMPL. C.M. PARA CONTRA ÂNGULO

CHAVE DE CAPTURA DE CONTRA ÂNGULO,
TORQUE MÁXIMO 35 N.cm

CHAVES DE INSTALAÇÃO



CHAVE CURTA P/ IMPL. O.C. C.M. P/ CATRACA



CHAVE LONGA P/ IMPL. O.C. C.M. P/ CATRACA



CHAVE DIGITAL HEXAGONAL MÉDIA



CHAVE DE MONTADOR PARA CONTRA ÂNGULO

EXPANSORES



EXPANSOR LAMINADOR CÔNICO LONGO Ø2,6



EXPANSOR LAMINADOR CÔNICO LONGO Ø2,9



EXPANSOR LAMINADOR CÔNICO LONGO Ø3,2



EXPANSOR LAMINADOR CÔNICO LONGO Ø3,7

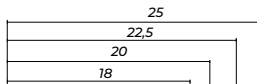

MEDIDORES

60088

MEDIDOR DE ANG. 17° E TRANSMUCOSO CM



60089

MEDIDOR DE ANG. 30° E TRANSMUCOSO CM



60090

MEDIDOR DE ANG. 45° E TRANSMUCOSO CM



ACESSÓRIOS

60084

SONDA CALBRADA PARA IMPLANTE LONGO

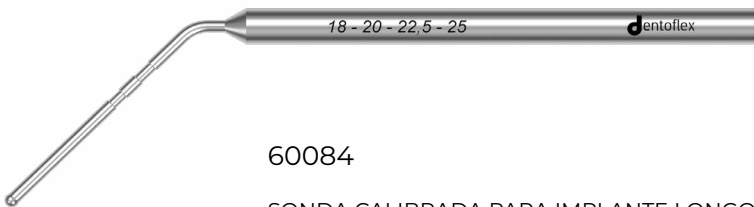

59711

GUIA DE POSICIONAMENTO ALL ON FOUR

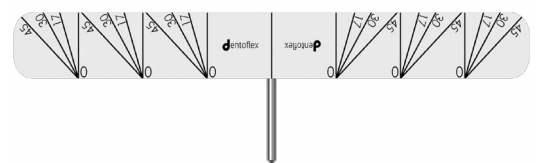

01393

CHAVE T FIXA



08877

CHAVE DE TORQUE



Ligomático



Zigomático

Hexágono Externo

SEGURANÇA PARA QUEM TEM MAXILA ATRÓFICA

Implantes Zigomáticos são ideais para casos que apresentam pouca altura óssea posterior em maxila, com proximidade dos seios maxilares e que necessitem de um ponto de ancoragem posterior, e tem a possibilidade de evitar o tratamento com enxertos ósseos, assim com o tempo reduzido de execução e finalização do tratamento, à diminuição dos custos e menor desconforto após a cirurgia, comparando as reconstruções maxilares extensas com enxertos ósseos.

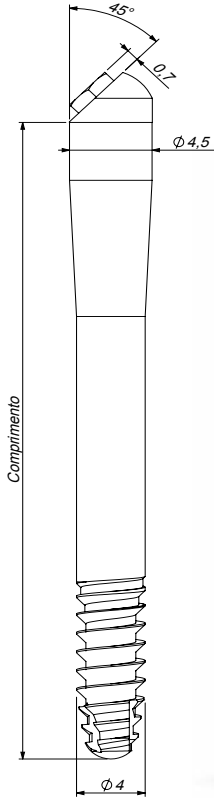

COMPRIMENTO	CÓDIGOS
30,0 mm	08359
32,5 mm	08360
35,0 mm	08361
37,5 mm	08362
40,0 mm	08363
42,5 mm	08364
45,0 mm	08365
47,5 mm	08366
50,0 mm	08367
52,5 mm	08368
55,0 mm	08369
57,5 mm	08370
60,0 mm	08371

*Para evitar a quebra do parafuso do montador durante a inserção do implante, na hora do aperto, é importante checar com frequência se o parafuso continua com torque e se o montador não ficou com folga na adaptação com o implante. Utilize a chave de apoio evitando movimentar o implante fora do eixo e alavancas excessivas com a chave tufo, diminuindo assim, a concentração de força no parafuso.

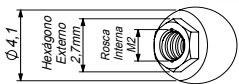

JP | DIÂMETRO 4,0 mm

PLATAFORMA 4,1 mm

MIRUSCONE ANGULADO

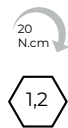

Ø 3,75	1,0 mm	17°	60236
	2,0 mm	17°	60237
	3,0 mm	17°	60238
Ø 3,75	1,0 mm	30°	60239
	2,0 mm	30°	60240
	3,0 mm	30°	60241

- ✓ Produzido em Titânio
- ✓ Distância oclusal mínima: 4,5mm
- ✓ Com transportador metálico
- ✓ Indicado para prótese múltipla e total

MIRUSCONE RETO



Ø 3,75	1,0 mm	56321
	2,0 mm	56323
	3,0 mm	56328

- ✓ Produzido em Titânio
- ✓ Distância oclusal mínima: 4,5mm
- ✓ Com transportador plástico
- ✓ Indicado para prótese múltipla e total

CAPA DE PROTEÇÃO PARA MIRUSCONE



53944

- ✓ Modelo único
- ✓ Produzido em Titânio

ANÁLOGO



56111

- ✓ Modelo único
- ✓ Produzido em Aço Inox

TRANSFER MOLDEIRA FECHADA



58575

- ✓ Modelo único
- ✓ Produzido em Aço Inox

TRANSFER MOLDEIRA ABERTA



57959

- ✓ Modelo único
- ✓ Produzido em Aço Inox

LUVA METÁLICA



57903

- ✓ Modelo único
- ✓ Produzido em Titânio

LUVA CINTA METÁLICA



57907

- ✓ Modelo único
- ✓ Cinta produzida em Cr-Co

LUVA PLÁSTICA



55343

- ✓ Modelo único
- ✓ Produzido em Poliacetal

Kit Zigomático



Criado especialmente para garantir a eficiência na dinâmica do seu consultório.

Estojo leve e de fácil manuseio, torna também o kit mais versátil e prático.

59822

KIT ZIGOMÁTICO

59821

ESTOJO KIT ZIGOMÁTICO

COMPONENTES

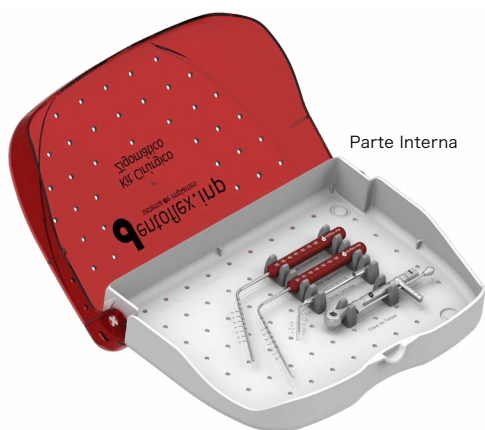

Parte Interna

Cod.	Descrição	Qtd.
01409	CABO PARA PONTA DE CHAVE TORQUE	1
59652	CHAVE DE APOIO PARA ZIGOMÁTICO	1
01415	CHAVE DE MONTADOR PARA CONTRA ANGULO	1
08877	CHAVE DE TORQUE	1
59653	CHAVE TUFO PARA ZIGOMÁTICO	1
06821	EXTENSOR DE BROCA	1
59708	FRESA CANALETA PARA ZIGOMATICO	1
59675	FRESA DE LSM	1
02032	FRESA ESCALONADA ZIGOMATICO 3,5 X 40	1
02031	FRESA ESCALONADA ZIGOMATICO 3,5 X 80	1
02029	FRESA ESCALONADA ZIGOMATICO 4 X 80	1
02132	FRESA LANÇA ZIGOMATICO 2,2 X 40	1
02131	FRESA LANÇA ZIGOMATICO 2,2 X 80	1
01397	PONTA DIGITAL P/ CHAVE TORQUE HEXAGONAL LONGA	1
01398	PONTA DIGITAL P/ CHAVE TORQUE QUADRADA LONGA	1
01407	PONTA ESFERICA P/ CHAVE DE TORQUE (HEX.2,0)	1
55832	SONDA CALIBRADA	1
59656	SONDA CALIBRADA BICORTICAL PARA ZIGOMÁTICO	1
59660	SONDA CALIBRADA PARA ZIGOMÁTICO	1

CHAVES



59652

CHAVE DE APOIO PARA ZIGOMÁTICO



59653

CHAVE TUFO PARA ZIGOMÁTICO

01415



CHAVE DE MONTADOR PARA CONTRA ÂNGULO



08877

CHAVE DE TORQUE

01409



CABO PARA PONTA DE CHAVE TORQUE

PONTEIRAS

01397



PONTA DIGITAL P/ CHAVE TORQUE HEXAGONAL LONGA

01398



PONTA DIGITAL P/ CHAVE TORQUE QUADRADA LONGA

01407



PONTA ESFERICA P/ CHAVE DE TORQUE (Hex.2,0)

FRESAS

59708



FRESA CANALETA PARA ZIGOMÁTICO

59675



FRESA DE LSM

02032



FRESA ESCALONADA ZIGOMÁTICO 3,5 X 40

02031



FRESA ESCALONADA ZIGOMÁTICO 3,5 X 80

02029



FRESA ESCALONADA ZIGOMÁTICO 4 X 80

02132



FRESA LANÇA ZIGOMÁTICO 2,2 X 40

02131



FRESA LANÇA ZIGOMÁTICO 2,2 X 80

06821



EXTENSOR DE BROCA

SONDAS

55832

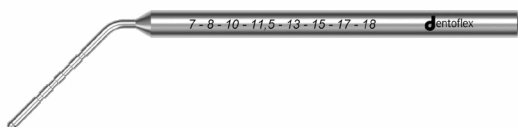

SONDA CALBRADA PARA IMPLANTE

59656

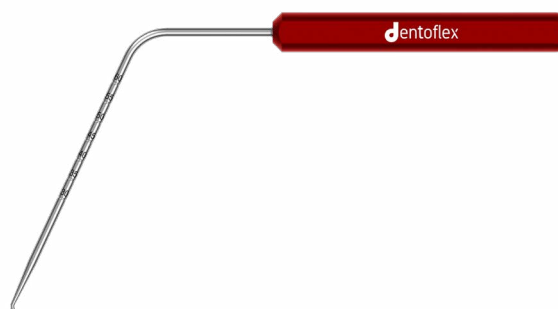

SONDA CALBRADA BICORTICAL PARA ZIGOMÁTICO

59660

SONDA CALBRADA PARA ZIGOMÁTICO



Solid



Solid

Definitivo

DIÂMETRO | COMPRIMENTO

Ø 2,60	10,0 mm 57370	13,0 mm 57371	15,0 mm 57470
--------	------------------	------------------	------------------

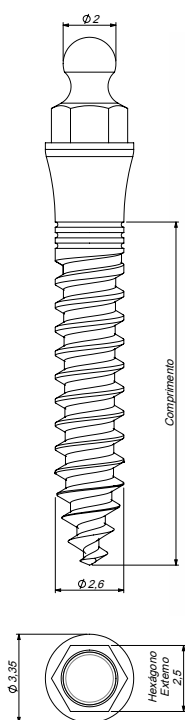

CHAVE DE INSTALAÇÃO DO IMPLANTE

55154

✓ Chave torquímetro
média 2,50 mm
para O'ring



CARACTERÍSTICAS:

Indicado para reabilitação de pequenos
espaços protéticos unitários

Indicado para retenção de próteses
fixas sobre implantes

Inserção facilitada: uso de somente
uma fresa de 1,8 mm para o preparo
ósseo

Ápice cortante

MUNHÃO RETO PRÓTESE CIMENTADA



58245

✓ Produzido em Titânio

MUNHÃO ANGULADO PRÓTESE CIMENTADA



58244

✓ Produzido em Titânio

✓ Disponível em 15°



CÁPSULA METÁLICA

✓ Produzido em Titânio

58279



ARRUELA ESPAÇADORA

✓ Produzido em Poliacetal
c/10 unidades

55341

Kit Protético



Por que é preferível ter um kit único que instala todos os modelos e marcas de componentes protéticos?

- Garante a eficiência
- Prioriza funcionalidade
- Praticidade
- Simplicidade
- Alta qualidade
- Peças versáteis
- Evita volume

55941
KIT PROTÉTICO

59239
ESTOJO KIT PROTÉTICO

COMPONENTES

Cod.	Descrição	Qtd.
01409	CABO PARA PONTA DE CHAVE TORQUE	1
08877	CHAVE DE TORQUE	1
01394	PONTA COIFA P/ CHAVE DE TORQUE HEX 2,7	1
59573	PONTA DIGITAL P/ CHAVE TORQUE HEX 1,60MM CURTA	1
59542	PONTA DIGITAL P/ CHAVE TORQUE HEX. 1,60MM LONGA	1
01395	PONTA DIGITAL P/ CHAVE TORQUE HEXAGONAL CURTA	1
01397	PONTA DIGITAL P/ CHAVE TORQUE HEXAGONAL LONGA	1
01396	PONTA DIGITAL P/ CHAVE TORQUE QUADRADA CURTA	1
01398	PONTA DIGITAL P/ CHAVE TORQUE QUADRADA LONGA	1
01407	PONTA ESFERICA P/ CHAVE DE TORQUE (Hex.2,0)	1
55154	PONTA PARA CHAVE DE TORQUE HEX. 2,5	1

CHAVES



08877
CHAVE DE TORQUE

01409



CABO PARA PONTA DE CHAVE TORQUE

01407



PONTA ESFÉRICA P/ CHAVE DE TORQUE (HEX.2,0)

55154



PONTA PARA CHAVE DE TORQUE (HEX. 2,5)

01394



PONTA COIFA P/ CHAVE DE TORQUE (HEX 2,7)

01395



PONTA DIGITAL P/ CHAVE TORQUE HEXAGONAL CURTA

01397



PONTA DIGITAL P/ CHAVE TORQUE HEXAGONAL LONGA

59573



PONTA DIGITAL P/ CHAVE TORQUE HEX 1,60MM CURTA

59542



PONTA DIGITAL P/ CHAVE TORQUE HEX. 1,60MM LONGA

01396



PONTA DIGITAL P/ CHAVE TORQUE QUADRADA CURTA

01398



PONTA DIGITAL P/ CHAVE TORQUE QUADRADA LONGA

Kit Tela

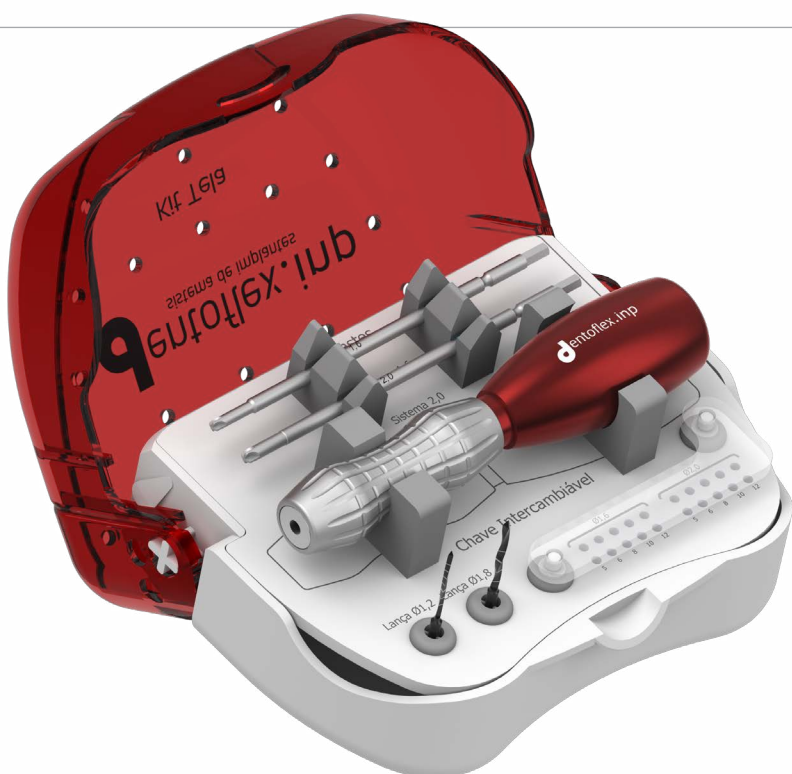

55049
KIT TELA

06515
ESTOJO KIT TELA

CARACTERÍSTICAS:

Cod.	Descrição	Qtd.
07096	PARAFUSO FIXADOR 1,6 X 6,0	Opcional
07089	PARAFUSO FIXADOR 1,6 X 8,0	Opcional
07092	PARAFUSO FIXADOR 1,6 X 10,0	Opcional
07095	PARAFUSO FIXADOR 1,6 X 12,0	Opcional
07098	PARAFUSO FIXADOR 1,6 X 14,0	Opcional
07132	PARAFUSO FIXADOR 2,0 X 6,0	Opcional
07136	PARAFUSO FIXADOR 2,0 X 8,0	Opcional
07140	PARAFUSO FIXADOR 2,0 X 10,0	Opcional
07144	PARAFUSO FIXADOR 2,0 X 12,0	Opcional
07148	PARAFUSO FIXADOR 2,0 X 14,0	Opcional
54027	TELA PARA ENXERTO 50 X 35 VAO 1,4 S	Opcional
02641	TELA PARA ENXERTO 60 X 40 VAO 2,5	Opcional
02642	TELA PARA ENXERTO 60 X 40 VAO 3,2	Opcional
01362	HASTE 1,6	Opcional
01373	HASTE 2,0	Opcional
01391	CHAVE INTERCAMBIÁVEL	Opcional
01337	LANÇA 1,2	Opcional
01340	LANÇA 1,8	Opcional

HASTES

01362



HASTE 1,6

01373



HASTE 2,0

FRESAS

01337



FRESA LANÇA 1,2

01340



FRESA LANÇA 1,8

CHAVE

01391

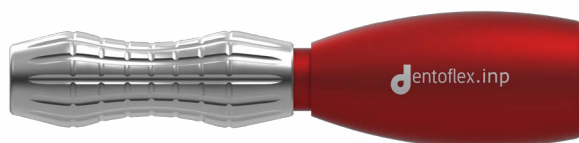

CHAVE INTERCAMBIÁVEL

PARAFUSOS

PARAFUSO FIXADOR 1.6

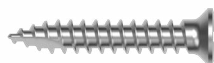

PARAFUSO FIXADOR 2.0

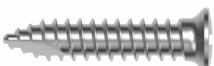

Cod.	Descrição
07096	PARAFUSO FIXADOR 1.6 X 6,0
07089	PARAFUSO FIXADOR 1.6 X 8,0
07092	PARAFUSO FIXADOR 1.6 X 10,0
07095	PARAFUSO FIXADOR 1.6 X 12,0
07098	PARAFUSO FIXADOR 1.6 X 14,0
07132	PARAFUSO FIXADOR 2.0 X 6,0
07136	PARAFUSO FIXADOR 2.0 X 8,0
07140	PARAFUSO FIXADOR 2.0 X 10,0
07144	PARAFUSO FIXADOR 2.0 X 12,0
07148	PARAFUSO FIXADOR 2.0 X 14,0

TELA PARA ENXERTO

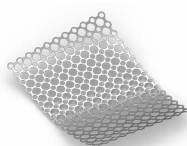
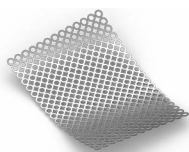
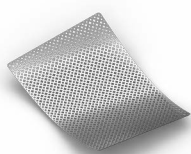

Cod.	Descrição
54027	TELA PARA ENXERTO 50 X 35 VAO 1,4 S
02641	TELA PARA ENXERTO 60 X 40 VAO 2,5
02642	TELA PARA ENXERTO 60 X 40 VAO 3,2

Kit Expansor

CARACTERÍSTICAS:

Cod.	Descrição	Qtd.
01415	CHAVE MONTADORA PARA CONTRA ANGULO	1
01419	EXPANSOR LAMINADOR CÔNICO 2,2	1
01420	EXPANSOR LAMINADOR CÔNICO 2,6	1
01421	EXPANSOR LAMINADOR CÔNICO 2,9	1
01422	EXPANSOR LAMINADOR CÔNICO 3,2	1
01423	EXPANSOR LAMINADOR CÔNICO 3,7	1
01424	EXPANSOR LAMINADOR CÔNICO 4,7	1
01425	EXPANSOR LAMINADOR CÔNICO 5,4	1



55047

KIT EXPANSOR

55331

ESTOJO KIT EXPANSOR

COMPONENTES

01415



CHAVE MONTADORA PARA CONTRA ÂNGULO

01419

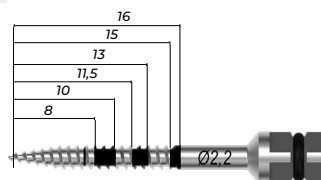

EXPANSOR LAMINADOR CÔNICO 2,2

01420



EXPANSOR LAMINADOR CÔNICO 2,6

01421



EXPANSOR LAMINADOR CÔNICO 2,9

01422



EXPANSOR LAMINADOR CÔNICO 3,2

01423



EXPANSOR LAMINADOR CÔNICO 3,7

01424



EXPANSOR LAMINADOR CÔNICO 4,7

01425



EXPANSOR LAMINADOR CÔNICO 5,4



🌐 dentoflex.com.br

✉ sac@inp-dentoflex.com

☎ Tel.: 55 11 2083 - 4130

📞 WhatsApp: +55 11 99589-8239

🌐 [@dentoflexbrasil](#) 📷 [@dentoflex.official](#)