

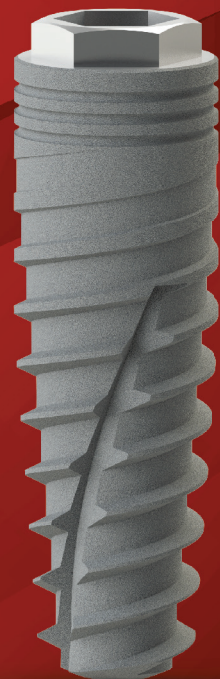

dentoflex.inp
sistema de implantes

CATÁLOGO DE PRODUTOS
2025

Supreme

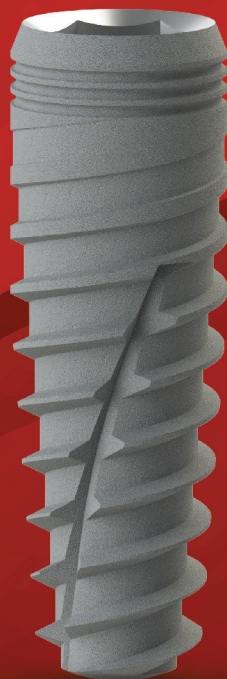
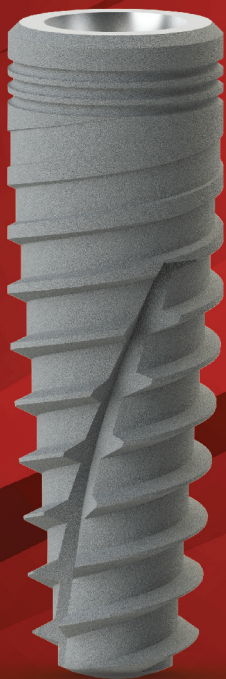

O MAIS RECOMENDADO PELOS ESPECIALISTAS

A conexão morse veio como uma evolução aos implantes HE e HI, que são usados até hoje. Superior quanto à adaptação da parte protética, com um encaixe perfeito da interface. Tem vantagens, não somente o selamento biológico da conexão, mas também biomecanicamente e esteticamente, e apresenta maior dinamismo nos procedimentos.

CARACTERÍSTICAS:

Produzido em Titânio ASTM F67 Grau IV
Corpo cônico, rosca dupla
Apresenta cone de 11,5° e rosca 1,8 mm
Plataforma Switch
Alta estabilidade inicial

Indicado para colocação na profundidade de 1, 2 e 3mm

Acompanha tapa implante

Recomendado para osso tipo I, II, III e IV. *Verificar sequência de brocas.

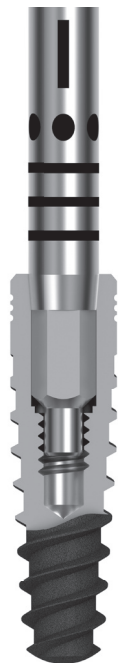

CHAVES DE CAPTURA E INSTALAÇÃO DO IMPLANTE



Disponível nos tamanhos
Curto e Longo

Descrição

Código

Chave Catraca Curta	55882
Chave Catraca Longa	55883
Chave C.A Curta	55834

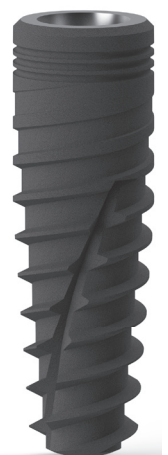

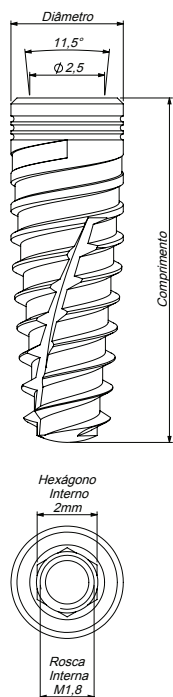

Diâmetro

Comprimentos

Ø 3,50	7,0 mm 60248	8,50 mm 56823	10,0 mm 56819	11,5 mm 56820	13,0 mm 56821	15,0 mm 56822
Ø 3,75	7,0 mm 60249	8,50 mm 56828	10,0 mm 56824	11,5 mm 56825	13,0 mm 56826	15,0 mm 56827
Ø 4,25	7,0 mm 60250	8,50 mm 56833	10,0 mm 56829	11,5 mm 56830	13,0 mm 56831	15,0 mm 56832
Ø 5,00	7,0 mm 60251	8,50 mm 56838	10,0 mm 56834	11,5 mm 56835	13,0 mm 56836	15,0 mm 56837

Sequência de Brocas

Implante	Lança	Supreme 3,5	Piloto Supreme 2,8 / 3,5	Supreme 3,75	Piloto Supreme 3,0 / 3,75	Supreme 4,25	Piloto Supreme 3,60 / 4,25	Supreme 5,00	Piloto Supreme 4,25 / 5,00
3,50 mm	●	●	○						
3,75 mm	●	●		●	○				
4,25 mm	●	●		●		●	○		
5,00 mm	●	●		●		●		●	○

○ Para osso tipo I e II

● Para osso tipo III e IV

TAPA IMPLANTE



1,0 mm

56839

CICATRIZADORES



Ø 3,30mm

0,8 mm	56152
1,5 mm	56153
2,5 mm	56154
3,5 mm	56155
4,5 mm	56253
5,5 mm	56254



Ø 4,50mm

0,8 mm	56256
1,5 mm	56257
2,5 mm	56258
3,5 mm	56259
4,5 mm	56260
5,5 mm	56261

TRANSFER MOLDEIRA ABERTA



57940

- ✓ Modelo único com index
- ✓ Produzido em Aço Inox

TRANSFER MOLDEIRA FECHADA



57864

- ✓ Modelo único com index
- ✓ Produzido em Aço Inox

ANÁLOGO DO IMPLANTE



56116

- ✓ Produzido em Aço Inox

MUNHÃO UNIVERSAL CONE MORSE



20
N.cm



- ✓ Disponível sem index
- ✓ Produzido em Titânio

MUNHÃO UNIVERSAL - SEM Index

Ø 3,30	4,0 mm	0,8 mm	58047
	4,0 mm	1,5 mm	58048
	4,0 mm	2,5 mm	58049
	4,0 mm	3,5 mm	58050
	4,0 mm	4,5 mm	58051
	4,0 mm	5,5 mm	58052
	6,0 mm	0,8 mm	58054
	6,0 mm	1,5 mm	58055
	6,0 mm	2,5 mm	58056
	6,0 mm	3,5 mm	58057
Ø 4,50	6,0 mm	4,5 mm	58058
	6,0 mm	5,5 mm	58059
	4,0 mm	0,8 mm	58061
	4,0 mm	1,5 mm	58095
	4,0 mm	2,5 mm	58096
	4,0 mm	3,5 mm	58097
	4,0 mm	4,5 mm	58098
	4,0 mm	5,5 mm	58099
	6,0 mm	0,8 mm	58101
	6,0 mm	1,5 mm	58102
6,0 mm	2,5 mm	58103	
6,0 mm	3,5 mm	58104	
6,0 mm	4,5 mm	58105	
6,0 mm	5,5 mm	58106	

MUNHÃO UNIVERSAL ANGULADO - COM Index



20
N.cm



- ✓ Disponível com index
- ✓ Produzido em Titânio

Ø 3,30	4,0 mm	17°	1,5 mm	56200
	4,0 mm	17°	2,5 mm	56203
	4,0 mm	17°	3,5 mm	56206
	4,0 mm	30°	1,5 mm	56202
	4,0 mm	30°	2,5 mm	56205
	4,0 mm	30°	3,5 mm	56208
	6,0 mm	17°	1,5 mm	56209
	6,0 mm	17°	2,5 mm	56212
	6,0 mm	17°	3,5 mm	56215
	6,0 mm	30°	1,5 mm	56211
	6,0 mm	30°	2,5 mm	56214
	6,0 mm	30°	3,5 mm	56217

Ø 4,50	4,0 mm	17°	1,5 mm	56218
	4,0 mm	17°	2,5 mm	57108
	4,0 mm	17°	3,5 mm	57111
	4,0 mm	30°	1,5 mm	56319
	4,0 mm	30°	2,5 mm	57110
	4,0 mm	30°	3,5 mm	57113
	6,0 mm	17°	1,5 mm	57114
	6,0 mm	17°	2,5 mm	57117
	6,0 mm	17°	3,5 mm	57120
	6,0 mm	30°	1,5 mm	57116
	6,0 mm	30°	2,5 mm	57119
	6,0 mm	30°	3,5 mm	57122

ANÁLOGO DO MUNHÃO UNIVERSAL



Ø 3,30	4,0 mm	56112
	6,0 mm	56113
Ø 4,50	4,0 mm	56114
	6,0 mm	56115

TRANSFER DO MUNHÃO UNIVERSAL



Ø 3,30	4,0 mm	Amarelo	57960
	6,0 mm	Azul	57961
Ø 4,50	4,0 mm	Amarelo	57962
	6,0 mm	Azul	57996

COIFA DO MUNHÃO UNIVERSAL

Calcinável
Antirrotacional



Temporária
Antirrotacional

Ø 3,30	4,0 mm	57173
	6,0 mm	57141
Ø 4,50	4,0 mm	57142
	6,0 mm	57143

Ø 3,30	4,0 mm	57144
	6,0 mm	57145
Ø 4,50	4,0 mm	57146
	6,0 mm	57147

UCLA CINTA METÁLICA CONE MORSE



0,8 mm	58028
1,5 mm	58063
2,5 mm	58065
3,5 mm	58067
4,5 mm	58069

✓ Cinta produzida em Cr-Co

MUNHÃO PROVISÓRIO CONE MORSE



0,8 mm	58180
1,5 mm	58181
2,5 mm	58182
3,5 mm	58183
4,5 mm	58184

✓ Produzido em Titânio

PILAR FLEX CONE MORSE



CINTA	CÓDIGOS
0,8 mm	57383
1,5 mm	57384
2,5 mm	57385
3,5 mm	57386
4,5 mm	57387
5,5 mm	57388

- ✓ Produzido em titânio
- ✓ Rosca de 2,0mm maior resistência
- ✓ Distância oclusal mínima: 6,5mm
- ✓ Parafusada unitária e múltipla

CAPA DE PROTEÇÃO



56151

- ✓ Modelo único
- ✓ Produzido em Titânio

ANÁLOGO



AR

56096

- ✓ Produzido em Aço Inox

TRANSFER MOLDEIRA ABERTA



57952

- ✓ Produzido em Aço Inox

TRANSFER MOLDEIRA FECHADA



59550

- ✓ Produzido em Aço Inox

LUVA METÁLICA



AR	57396
Circular	57398

- ✓ Disponível AR e Circular
- ✓ Produzido em Titânio

LUVA PLÁSTICA



AR	57389
Circular	57393

- ✓ Disponível AR e Circular
- ✓ Produzido em Poliacetal

LUVA CINTA METÁLICA



AR	57391
Circular	57394

- ✓ Disponível AR e Circular
- ✓ Cinta produzida em Cr-Co

OVERDENTURE / SISTEMA O'RING



CINTA	CÓDIGOS
0,8 mm	58344
1,5 mm	58345
2,5 mm	58346
3,5 mm	58347
4,5 mm	58348
5,5 mm	58349

- ✓ Acompanha cápsula de titânio e arruela espaçadora
- ✓ Produzido em Titânio

O'RING FUNDÍVEL



- ✓ Utilizado em raiz natural ou em posição distal da barra-clip
- ✓ Acompanha cápsula de titânio e arruela espaçadora
- ✓ Produzido em Poliacetal

58350



CÁPSULA METÁLICA

58279

- ✓ Produzido em Titânio



ARRUELA ESPAÇADORA

55341

- ✓ Produzido em Poliacetal
- c/10 unidades



ANEL O'RING 10 und.

56227

- ✓ Produzido em Borracha

CONJUNTO BARRA CLIP

59246	BARRA
56660	CLIP 35°
56661	CLIP 70°
56662	CLIP RETO

- ✓ Indicado para uso em Implantes com distância mínima de 22 mm
- ✓ Produzido em Poliacetal

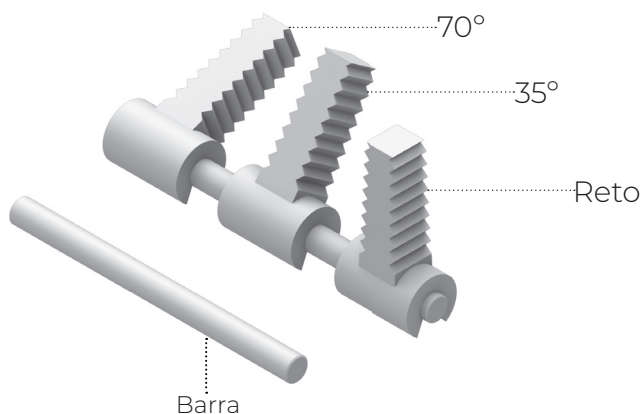

MIRUSCONE ANGULADO CONE MORSE



1,5 mm	17°	57925
2,5 mm	17°	57928
3,5 mm	17°	57964
1,5 mm	30°	57927
2,5 mm	30°	57963
3,5 mm	30°	57966

- ✓ Produzido em Titânio
- ✓ Com Index
- ✓ Com parafuso passante
- ✓ Não deve ser usado para unitário
- ✓ Com transportador metálico
- ✓ Indicado para prótese Multipla e Total

MIRUSCONE RETO CONE MORSE



0,8 mm	57910
1,5 mm	57911
2,5 mm	57915
3,5 mm	57919
4,5 mm	57923
5,5 mm	57924

- ✓ Produzido em Titânio
- ✓ Distância oclusal mínima: 4,5mm
- ✓ Não deve ser usado para unitário
- ✓ Com transportador plástico
- ✓ Indicado para prótese Multipla e Total

CAPA DE PROTEÇÃO PARA MIRUSCONE



53944

- ✓ Modelo único
- ✓ Produzido em Titânio

ANÁLOGO



56111

- ✓ Modelo único
- ✓ Produzido em Aço Inox

TRANSFER MOLDEIRA ABERTA



57959

- ✓ Modelo único
- ✓ Produzido em Aço Inox

TRANSFER MOLDEIRA FECHADA



58575

- ✓ Modelo único
- ✓ Produzido em Aço Inox

LUVA METÁLICA



57903

- ✓ Modelo único
- ✓ Produzido em Titânio

LUVA CINTA METÁLICA



57907

- ✓ Modelo único
- ✓ Cinta produzida em Cr-Co

LUVA PLÁSTICA



55343

- ✓ Modelo único
- ✓ Produzido em Poliacetal

ESTABILIDADE DE CONEXÃO

Corpo cônico os implantes hexágono interno conseguem alcançar uma boa estabilidade primária e são compatíveis com todos os tipos ósseos, mesmo em casos de osso não compactado. Pode ser utilizado em qualquer tipo de restauração protética, aparafusada e cimentada.

CARACTERÍSTICAS:

Produzido em Titânio ASTM F67 Grau IV

Corpo cônico, rosca dupla

Plataforma Switch

Hexágono Interno 2,50 mm

Rosca interna de 2,00 mm

Alta estabilidade inicial

Acompanha tampa implante

Recomendado para osso tipo I, II, III e IV. *Verificar sequência de brocas.

CHAVE DE CAPTURA E INSTALAÇÃO



Disponível nos tamanhos
Curto e Longo

Chaves para captura do
Implante, finalização deverá ser
com intermediário para catraca.

Descrição	Código
Intermediário Catraca Curta	57755
Intermediário Catraca Longa	57756
Chave C.A Curta	57753

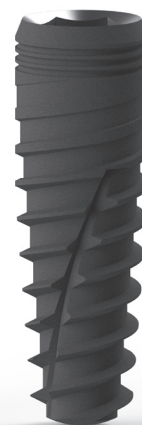
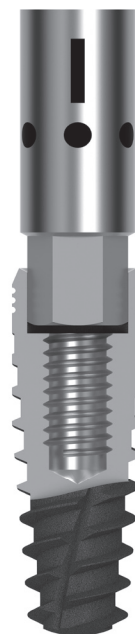

Diâmetro

Comprimentos

Ø 3,50	7,0 mm 60256	8,50 mm 56955	10,0 mm 56951	11,5 mm 56952	13,0 mm 56953	15,0 mm 56954
Ø 3,75	7,0 mm 60257	8,50 mm 56960	10,0 mm 56956	11,5 mm 56957	13,0 mm 56958	15,0 mm 56959
Ø 4,25	7,0 mm 60258	8,50 mm 56965	10,0 mm 56961	11,5 mm 56962	13,0 mm 56963	15,0 mm 56964
Ø 5,00	7,0 mm 60259	8,50 mm 56970	10,0 mm 56966	11,5 mm 56967	13,0 mm 56968	15,0 mm 56969

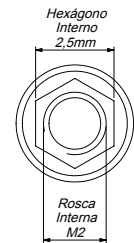
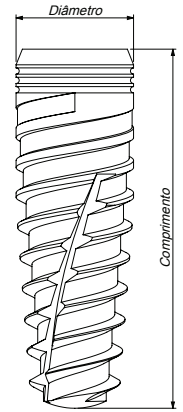

Sequência de Brocas

Switch	Implante	Lança	Supreme 3,5	Piloto Supreme 2,8 / 3,5	Supreme 3,75	Piloto Supreme 3,0 / 3,75	Supreme 4,30	Piloto Supreme 3,60 / 4,30	Supreme 5,00	Piloto Supreme 4,30 / 5,00
3,25 mm	3,50 mm	●	●	○						
3,25 mm	3,75 mm	●	●		●	○				
3,75 mm	4,25 mm	●	●		●		●	○		
4,25 mm	5,00 mm	●	●		●		●		●	○

○ Para osso tipo I e II

● Para osso tipo III e IV

CICATRIZADORES



3,25 mm	3,0 mm	57809
	5,0 mm	57810
	7,0 mm	57811
3,75 mm	3,0 mm	57816
	5,0 mm	57817
	7,0 mm	57818
4,25 mm	3,0 mm	57822
	5,0 mm	57823
	7,0 mm	57824

3,25 mm	3,0 mm	5,0 mm	55994
	5,0 mm	5,0 mm	55997
3,75 mm	3,0 mm	5,0 mm	56012
	5,0 mm	5,0 mm	56015
4,25 mm	3,0 mm	5,0 mm	56128
	5,0 mm	5,0 mm	56131

ANÁLOGO DO IMPLANTE



Ø 3,25	56103
Ø 3,75	56105
Ø 4,25	56107

✓ Produzido em Aço Inox

TRANSFER MOLDEIRA ABERTA



57938

- ✓ Modelo único para todos os diâmetros
- ✓ Altura única
- ✓ Produzido em Aço Inox

TRANSFER MOLDEIRA FECHADA



58569

- ✓ Altura única
- ✓ Produzido em Aço Inox

UCLA CINTA METÁLICA AR E CIRCULAR



1,3

AR CIRCULAR

	AR	CIRCULAR
Ø 3,25	58132	58087
Ø 3,75	58134	58089
Ø 4,25	58136	58091

- ✓ Disponível em três diâmetros
- ✓ Altura única
- ✓ Cinta produzida em Cr-Co

UCLA PLÁSTICA AR E CIRCULAR



1,3

AR CIRCULAR

	AR	CIRCULAR
Ø 3,25	58007	58019
Ø 3,75	58009	55303
Ø 4,25	58011	58023

- ✓ Disponível em três diâmetros
- ✓ Altura única
- ✓ Produzido em Poliacetal

MUNHÃO ANGULADO



- ✓ Disponível em três diâmetros
- ✓ Produzido em Titânio

Ø 3,25	1,0 mm	15°	56465
	2,0 mm	15°	56467
	3,0 mm	15°	56469
	1,0 mm	25°	56473
	2,0 mm	25°	56475
	3,0 mm	25°	56477
	1,0 mm	35°	56480
	2,0 mm	35°	56482
	3,0 mm	35°	56846
Ø 3,75	1,0 mm	15°	56865
	2,0 mm	15°	56867
	3,0 mm	15°	56869
	1,0 mm	25°	56872
	2,0 mm	25°	56874
	3,0 mm	25°	56876
	1,0 mm	35°	57240
	2,0 mm	35°	57242
	3,0 mm	35°	57244
Ø 4,25	1,0 mm	15°	57257
	2,0 mm	15°	57259
	3,0 mm	15°	57260
	1,0 mm	25°	57262
	2,0 mm	25°	57264
	3,0 mm	25°	57265
	1,0 mm	35°	57267
	2,0 mm	35°	57269
	3,0 mm	35°	57271

MUNHÃO TEMPORÁRIO CIRCULAR



- ✓ Disponível em três diâmetros
- ✓ Altura única
- ✓ Produzido em Titânio

Ø 3,25	58260
Ø 3,75	58262
Ø 4,25	58264

MUNHÃO PARA PRÓTESE CIMENTADA



- ✓ Disponível em três diâmetros
- ✓ Produzido em Titânio

Ø 3,25	1,0 mm	56588
	2,0 mm	56589
	3,0 mm	56590
Ø 3,75	1,0 mm	56597
	2,0 mm	56598
	3,0 mm	56599
Ø 4,25	1,0 mm	56606
	2,0 mm	56607
	3,0 mm	56608

MUNHÃO TEMPORÁRIO AR



Ø 3,25	58249
Ø 3,75	58251
Ø 4,25	58253

- ✓ Disponível em três diâmetros
- ✓ Altura única
- ✓ Produzido em Titânio

MIRUSCONE ANGULADO

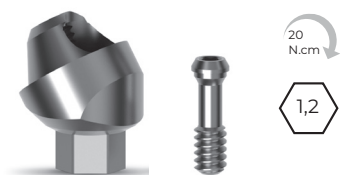

- ✓ Produzido em Titânio
- ✓ Disponível em dois tamanhos
- ✓ Distância oclusal mínima: 4,5mm
- ✓ Com transportador metálico
- ✓ Indicado para prótese Múltipla e Total

Ø 3,25	1,0 mm	17°	56333
	2,0 mm	17°	56334
	3,0 mm	17°	56336
	1,0 mm	30°	56345
	2,0 mm	30°	56347
	3,0 mm	30°	56349
Ø 3,75	1,0 mm	17°	56725
	2,0 mm	17°	56727
	3,0 mm	17°	56729
	1,0 mm	30°	56739
	2,0 mm	30°	56741
	3,0 mm	30°	56743

MIRUSCONE RETO



- ✓ Produzido em Titânio
- ✓ Distância oclusal mínima: 4,5mm
- ✓ Não deve ser usado para unitário
- ✓ Com transportador plástico
- ✓ Indicado para prótese múltipla e total

Ø 3,25	1,0 mm	56331
	2,0 mm	56337
	3,0 mm	56343
Ø 3,75	1,0 mm	56723
	2,0 mm	56730
	3,0 mm	56737
Ø 4,25	1,0 mm	58512
	2,0 mm	58513
	3,0 mm	58514

CAPA DE PROTEÇÃO PARA MIRUSCONE



53944

- ✓ Modelo único
- ✓ Produzido em Titânio

ANÁLOGO



56111

- ✓ Modelo único
- ✓ Produzido em Aço Inox

TRANSFER MOLDEIRA ABERTA



57959

- ✓ Modelo único
- ✓ Produzido em Aço Inox

TRANSFER MOLDEIRA FECHADA



58575

- ✓ Modelo único
- ✓ Produzido em Aço Inox

LUVA METÁLICA



57903

- ✓ Modelo único
- ✓ Produzido em Titânio

LUVA CINTA METÁLICA



57907

- ✓ Modelo único
- ✓ Cinta produzida em Cr-Co

LUVA PLÁSTICA



55343

- ✓ Modelo único
- ✓ Produzido em Poliacetal

OVERDENTURE



Ø 3,25	1,0 mm	58297
	2,0 mm	58298
	3,0 mm	58299
	4,0 mm	58300
	5,0 mm	58301
Ø 3,75	1,0 mm	58309
	2,0 mm	58311
	3,0 mm	58312
	4,0 mm	58313
Ø 4,25	5,0 mm	58314
	1,0 mm	58322
	2,0 mm	58323
	3,0 mm	58324
	4,0 mm	58325
	5,0 mm	58326

- ✓ Acompanha cápsula de titânio e arruela espaçadora
- ✓ Produzido em Titânio

O'RING FUNDÍVEL



- ✓ Utilizado em raiz natural ou em posição distal da barra-clip
- ✓ Acompanha cápsula de titânio e arruela espaçadora
- ✓ Produzido em Poliacetal

58350



CÁPSULA METÁLICA

58279

- ✓ Produzido em Titânio



ARRUELA ESPAÇADORA

55341

- ✓ Produzido em Poliacetal
- c/10 unidades



ANEL O'RING 10 und.

56227

- ✓ Produzido em Borracha

CONJUNTO BARRA CLIP

59246	BARRA
56660	CLIP 35°
56661	CLIP 70°
56662	CLIP RETO

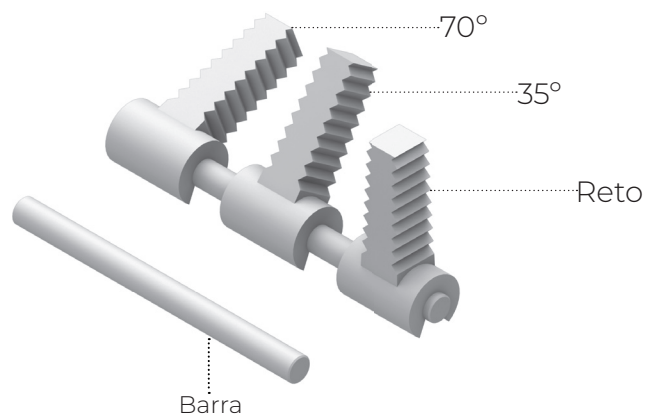

- ✓ Indicado para uso em Implantes com distância mínima de 22 mm
- ✓ Produzido em Poliacetal

Supreme

Hexágono Externo

UMA BOA ALTERNATIVA PARA REABILITAÇÃO DENTÁRIA

Os implantes hexágono externo atendem todos os tipos de reabilitações protéticas, sendo possível ser feito com carga imediata ou precoce. Seu sistema abrange uma grande variedade de componentes protéticos o que facilita a escolha da solução adequada para cada paciente.

CARACTERÍSTICAS:

Produzido em Titânio ASTM F67 Grau IV

Corpo cônico, rosca dupla

Plataforma Switch

Hexágono Externo 2,70 mm

Altura do hexágono 0,70 mm

Rosca interna de 2,00 mm

Alta estabilidade inicial

Acompanha tampa implante

Recomendado para osso tipo I, II, III e IV. *Verificar sequência de brocas.

Torque Interno

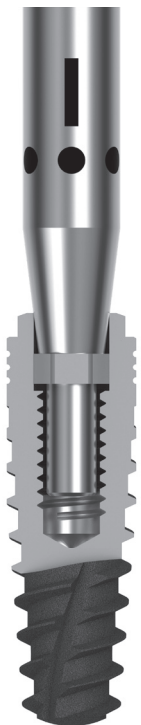

CHAVES DE CAPTURA E INSTALAÇÃO DO IMPLANTE



Disponível nos tamanhos Curto e Longo

Chaves para captura do Implante, finalização deverá ser com intermediário para catraca.

Descrição	Código
Chave Catraca Curta	55882
Chave Catraca Longa	55883
Chave C.A Curta	55851



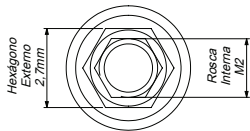
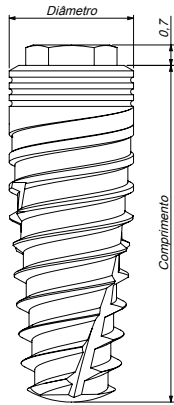

Diâmetro

Comprimentos

Ø 3,75	8,50 mm 57079	10,0 mm 57075	11,5 mm 57076	13,0 mm 57077	15,0 mm 57078
Ø 4,25	8,50 mm 57084	10,0 mm 57080	11,5 mm 57081	13,0 mm 57082	15,0 mm 57083
Ø 5,00	8,50 mm 57089	10,0 mm 57085	11,5 mm 57086	13,0 mm 57087	15,0 mm 57088

Sequência de Brocas

Implante	Lança	Supreme 3,5	Piloto Supreme 2,8 / 3,5	Supreme 3,75	Piloto Supreme 3,0 / 3,75	Supreme 4,30	Piloto Supreme 3,60 / 4,30	Supreme 5,00	Piloto Supreme 4,30 / 5,00
3,75 mm	●	●		●	○				
4,25 mm	●	●		●		●	○		
5,00 mm	●	●		●		●		●	○

○ Para osso tipo I e II

● Para osso tipo III e IV

CICATRIZADORES



07635	CICATRIZADOR W 4,1 X 3,0 X 5,4
01280	CICATRIZADOR W 4,1 X 4,0 X 5,4
07638	CICATRIZADOR W 4,1 X 6,0 X 5,4



07518	CICATRIZADOR PARALELO 4,1 X 3,0
07519	CICATRIZADOR PARALELO 4,1 X 4,0
07521	CICATRIZADOR PARALELO 4,1 X 6,0

TRANSFER MOLDEIRA ABERTA



1,2

55345

- ✓ Modelo único para todos os diâmetros
- ✓ Produzido em Aço Inox

TRANSFER MOLDEIRA FECHADA



1,2

58565

- ✓ Modelo único para todos os diâmetros
- ✓ Produzido em Aço Inox

ANÁLOGO DO IMPLANTE



Ø 3,75

56100

- ✓ Produzido em Aço Inox

UCLA CINTA METÁLICA AR E CIRCULAR



32
N.cm

1,3

	AR	CIRCULAR
Ø 3,75	58129	58084

- ✓ Altura única
- ✓ Cinta produzida em Cr-Co

UCLA PLÁSTICA AR E CIRCULAR



32
N.cm

1,3

	AR	CIRCULAR
Ø 3,75	58003	58016

- ✓ Altura única
- ✓ Produzido em Poliacetal

MUNHÃO ANGULADO



Ø 3,75	1,0 mm	15°	56451
	2,0 mm	15°	56452
	3,0 mm	15°	56453
	1,0 mm	25°	56455
	2,0 mm	25°	56456
	3,0 mm	25°	56457
	1,0 mm	35°	56459
	2,0 mm	35°	56460
	3,0 mm	35°	56461

✓ Produzido em Titânio

MUNHÃO TEMPORÁRIO AR



Ø 3,75	58247
--------	-------

✓ Produzido em Titânio

MUNHÃO TEMPORÁRIO CIRCULAR



Ø 3,75	58258
--------	-------

✓ Produzido em Titânio

MUNHÃO PARA PRÓTESE CIMENTADA



Ø 3,75	1,0 mm	56582
	2,0 mm	56583
	3,0 mm	56584

✓ Produzido em Titânio

MIRUSCONE ANGULADO



Ø 3,75	1,0 mm	17°	57796
	2,0 mm	17°	57797
	3,0 mm	17°	56320
	1,0 mm	30°	56325
	2,0 mm	30°	56326
	3,0 mm	30°	56327

- ✓ Produzido em Titânio
- ✓ Distância oclusal mínima: 4,5mm
- ✓ Com transportador metálico
- ✓ Indicado para prótese múltipla e total

MIRUSCONE RETO



Ø 3,75	1,0 mm	57795
	2,0 mm	56322
	3,0 mm	56324

- ✓ Produzido em Titânio
- ✓ Distância oclusal mínima: 4,5mm
- ✓ Com transportador plástico
- ✓ Indicado para prótese múltipla e total

CAPA DE PROTEÇÃO PARA MIRUSCONE



53944

- ✓ Modelo único
- ✓ Produzido em Titânio

ANÁLOGO



56111

- ✓ Modelo único
- ✓ Produzido em Aço Inox

TRANSFER MOLDEIRA ABERTA



57959

- ✓ Modelo único
- ✓ Produzido em Aço Inox

TRANSFER MOLDEIRA FECHADA



58575

- ✓ Modelo único
- ✓ Produzido em Aço Inox

LUVA METÁLICA



57903

- ✓ Modelo único
- ✓ Produzido em Titânio

LUVA CINTA METÁLICA



57907

- ✓ Modelo único
- ✓ Cinta produzida em Cr-Co

LUVA PLÁSTICA



55343

- ✓ Modelo único
- ✓ Produzido em Poliacetal

OVERDENTURE / SISTEMA O'RING



✓ Acompanha cápsula de titânio e arruela espaçadora

✓ Produzido em Titânio

Ø 3,75	1,0 mm	58287
	2,0 mm	58289
	3,0 mm	58290
	4,0 mm	58292
	5,0 mm	58293

O'RING FUNDÍVEL



✓ Utilizado em raiz natural ou em posição distal da barra-clip

✓ Acompanha cápsula de titânio e arruela espaçadora

✓ Produzido em Poliacetal

58350



CÁPSULA METÁLICA

58279

✓ Produzido em Titânio



ARRUELA ESPAÇADORA

55341

✓ Produzido em Poliacetal
c/ 10 unidades



ANEL O'RING 10 und.

56227

✓ Produzido em Borracha

CONJUNTO BARRA CLIP

59246	BARRA
56660	CLIP 35°
56661	CLIP 70°
56662	CLIP RETO

✓ Indicado para uso em Implantes com distância mínima de 22 mm

✓ Produzido em Poliacetal

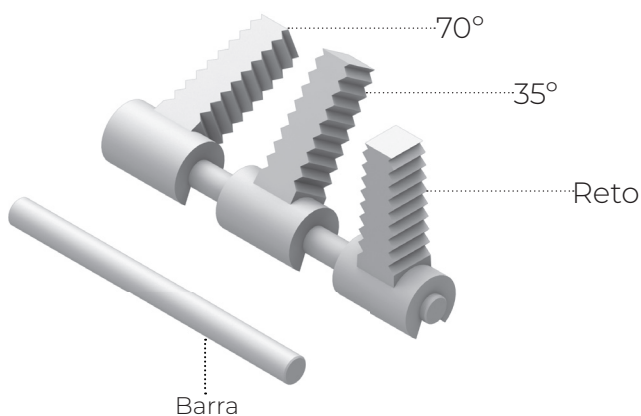

Kit Cirúrgico

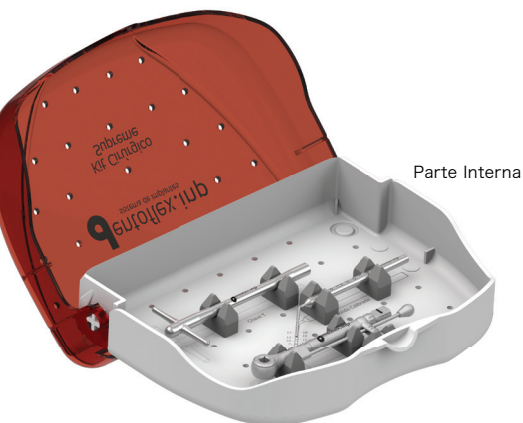
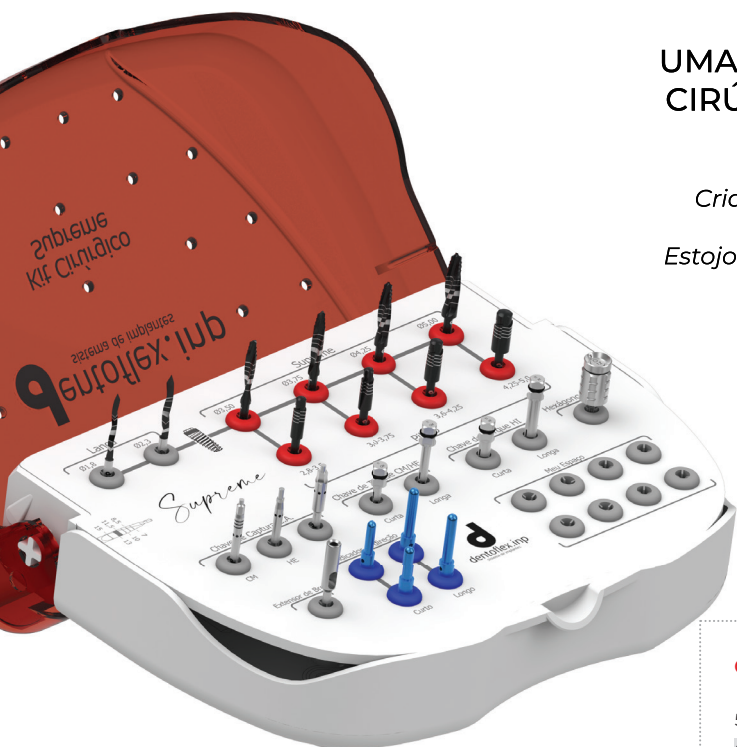

Parte Interna

UMA DAS PRINCIPAIS VANTAGENS DO KIT CIRÚRGICO É QUE ELE PODE SER USADO EM TODA A LINHA SUPREME

Criado especialmente para garantir a eficiência na dinâmica do seu consultório. Estejo leve e de fácil manuseio, torna também o kit mais versátil e prático.

55932

KIT CIRÚRGICO

07739

ESTOJO KIT CIRÚRGICO

COMPONENTES

Cod.	Descrição	Qtd.
59926	BROCA LANÇA	1
55750	BROCA LANÇA TRI-HELICOIDAL Ø2,30	1
56880	BROCA PILOTO SUPREME 2,8-3,5	1
55729	BROCA SUPREME Ø3,50	1
56881	BROCA PILOTO SUPREME 3,0-3,75	1
55731	BROCA SUPREME Ø3,75	1
56882	BROCA PILOTO SUPREME 3,6-425	1
55738	BROCA SUPREME Ø4,25	1
56883	BROCA PILOTO SUPREME 4,25-5,0	1
56879	BROCA SUPREME Ø5,00	1
55834	CHAVE CURTA P/ IMPL. O.C. C.M. P/ C.A.	1
55882	CHAVE CURTA P/ IMPL. O.C. C.M. P/ CATRACA	1
55851	CHAVE CURTA P/ IMPL. T.I. P/ C.A.	1
08877	CHAVE DE TORQUE	1
01379	CHAVE DIGITAL HEXAGONAL MÉDIA	1
55883	CHAVE LONGA P/ IMPL. O.C. C.M. P/ CATRACA	1
01393	CHAVE T FIXA	1
06821	EXTENSOR DE BROCA	1
57750	INDICADOR DE DIREÇÃO CURTO ACESS. P/ IMPL.	2
57751	INDICADOR DE DIREÇÃO LONGO ACESS. P/ IMPL.	2
57753	INTERMEDIÁRIO CURTO P/ C.A. P/ IMPL. HI	1
57755	INTERMEDIÁRIO P/ CATRACA CURTO P/ IMPL. HI	1
57756	INTERMEDIÁRIO P/ CATRACA LONGO P/ IMPL. HI	1
55832	SONDA CALIBRADA P/ IMPLANTE	1

PARA USO EM TODA

Linha Supreme

CONE MORSE / HE / HI

Kit único e versátil: evite volume, priorize a qualidade, funcionalidade, e a eficiência no seu dia a dia.

Mais eficiência para maximização de resultados

Menos materiais para manusear

Número reduzido de erros ou enganos

Menor ocupação do espaço físico

Mais agilidade nos procedimentos

BROCAS

59926 

BROCA LANÇA

55750 

BROCA LANÇA TRI-HELICOIDAL Ø2,30

56880 

BROCA PILOTO SUPREME 2,8-3,5

56881 

BROCA PILOTO SUPREME 3,0-3,75

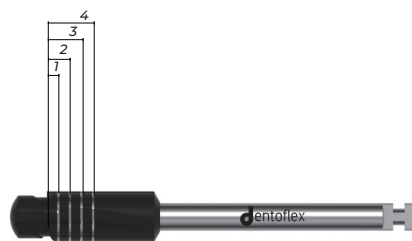
56882 
The diagram shows four drill bits of increasing length, labeled 1, 2, 3, and 4.

BROCA PILOTO SUPREME 3,6-4,25

56883 

BROCA PILOTO SUPREME 4,25-5,0

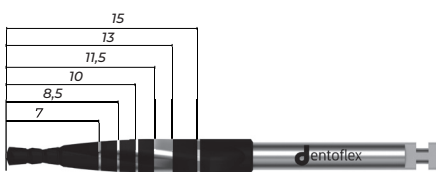
55729 
The diagram shows five drill bits of increasing length, labeled 7, 8,5, 10, 11,5, 13, and 15.

BROCA SUPREME Ø3,50

55731 

BROCA SUPREME Ø3,75

55738 

BROCA SUPREME Ø4,25

56879 

BROCA SUPREME Ø5,00

CHAVES

CHAVES DE CAPTURA

55834



CHAVE PARA IMPL. C.M. PARA CONTRA ÂNGULO

55851



CHAVE PARA IMPL. H.E PARA CONTRA ÂNGULO

57753



CHAVE PARA IMPL. H.I. PARA CONTRA ÂNGULO

CHAVE DE CAPTURA DE CONTRA ÂNGULO,
TORQUE MÁXIMO 35 N.cm

CHAVES DE INSTALAÇÃO

55882



CHAVE CURTA P/ IMPL. O.C.. C.M P/ CATRACA

>> CHAVES DE INSTALAÇÃO PARA CM E HE

55883



CHAVE LONGA P/ IMPL. O.C. C.M P/ CATRACA

57755



INTERMEDIÁRIO P/ CATRACA CURTO P/ IMPL. HI

57756



INTERMEDIÁRIO P/ CATRACA LONGO P/ IMPL. HI

01379



CHAVE DIGITAL HEXAGONAL MÉDIA

06821



EXTENSOR DE BROCA

INDICADORES

57750



INDICAÇÃO DE DIREÇÃO CURTO

57751



INDICADOR DE DIREÇÃO LONGO

01393

CHAVE T FIXA



55832

SONDA CALIBRADA PARA IMPLANTE

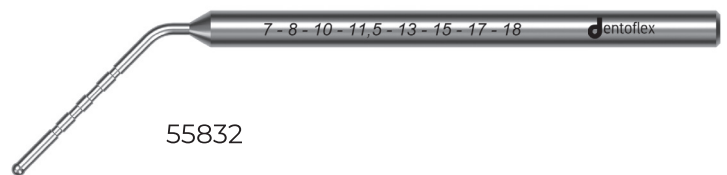

08877

CHAVE DE TORQUE





🌐 dentoflex.com.br

✉ sac@inp-dentoflex.com

☎ Tel.: 55 11 2083 - 4130

📞 WhatsApp: +55 11 99589-8239

📷 @DENTOFLEX.OFICIAL