



dentoflex.inp
sistema de implantes

CATÁLOGO DE PRODUTOS
2025

Supreme Guided

CIRURGIA 100% GUIADA INTUITIVO, DESIGN ADMIRADO E PRECISÃO

Integramos soluções de odontologia digital, garantindo simplicidade de uso, economia e ótimos resultados.



- Material Polímero de PPSU: não oxida e não apresenta manchas;
- Autoclaváveis em até 135°C / 275°F;
- Borrachas em silicone e coloridas para identificação das brocas;
- Escalas para verificação da marcação das ferramentas;
- Tampa inclinável serve de apoio da plataforma no momento da abertura;
- Acomodação para a torquímetro para autoclavagem;
- Estojo leve e de fácil manuseio.

60233
ESTOJO KIT CIRURGIA GUIADA

55929
KIT CIRURGIA GUIADA



Broca

Ø 1,3mm



56765

Fixadores de Guia



56666

Estabilizadores de Guia

CM



56664

HI - HE



56665

Punch

Ø 4,3mm



57742

Brocas

Lança

Escalonada

Ø 3,5mm

8,5 10 11,5 13

Ø 3,75mm

8,5 10 11,5 13

Ø 2,8 - 3,5

Ø 3,0 - 3,75



59962



60338



59987



59989



59991



59993



60003



60004

Chaves de Captura para C.A.

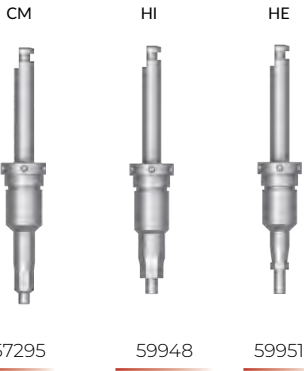

Chaves de Torque

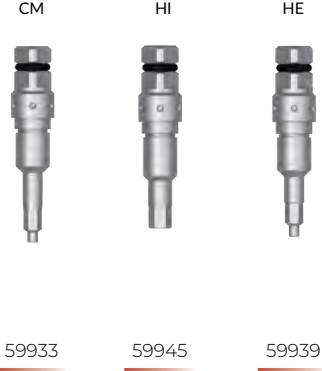

Chaves



Acessórios



Anilhas



Guias para Fixadores



*Supreme
Guided*

SEQUÊNCIA DE FRESAS

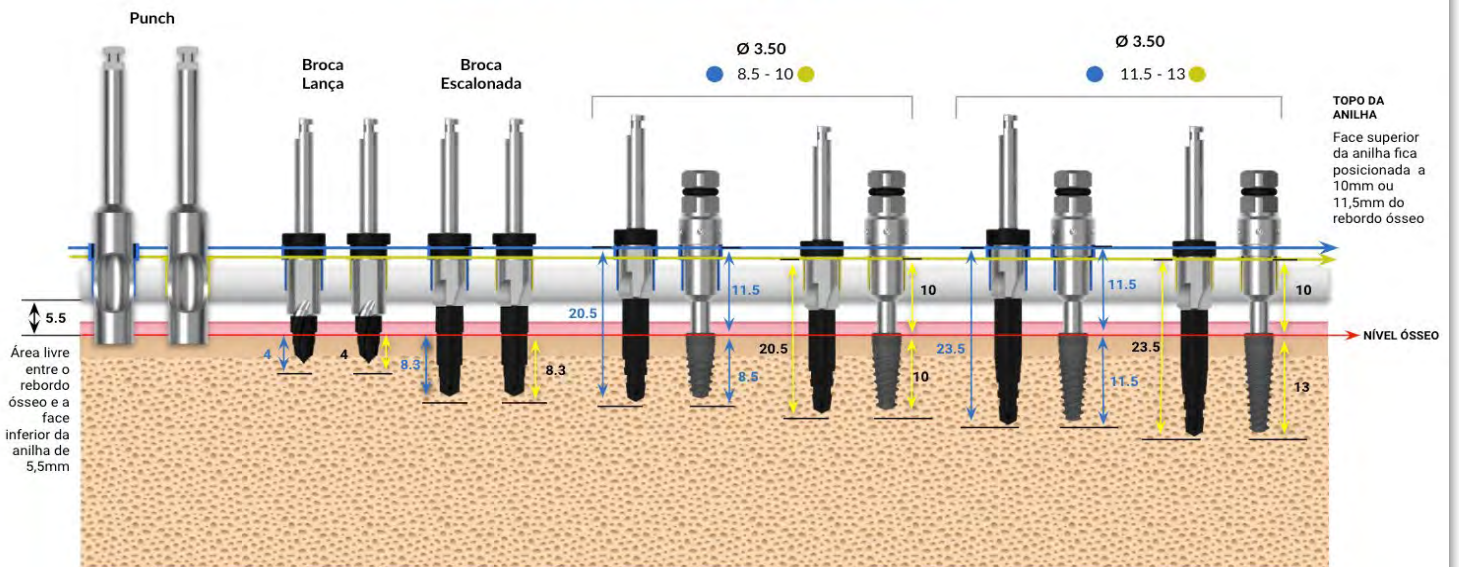

Comuniquem com o seu paciente de maneira clara e precisa

Com base nas particularidades de cada paciente o planejamento virtual pré-operatório, permitirá que você comunique a esse paciente, sobre como será o tratamento, revelando detalhes do procedimento como: precisão, simplicidade e segurança.





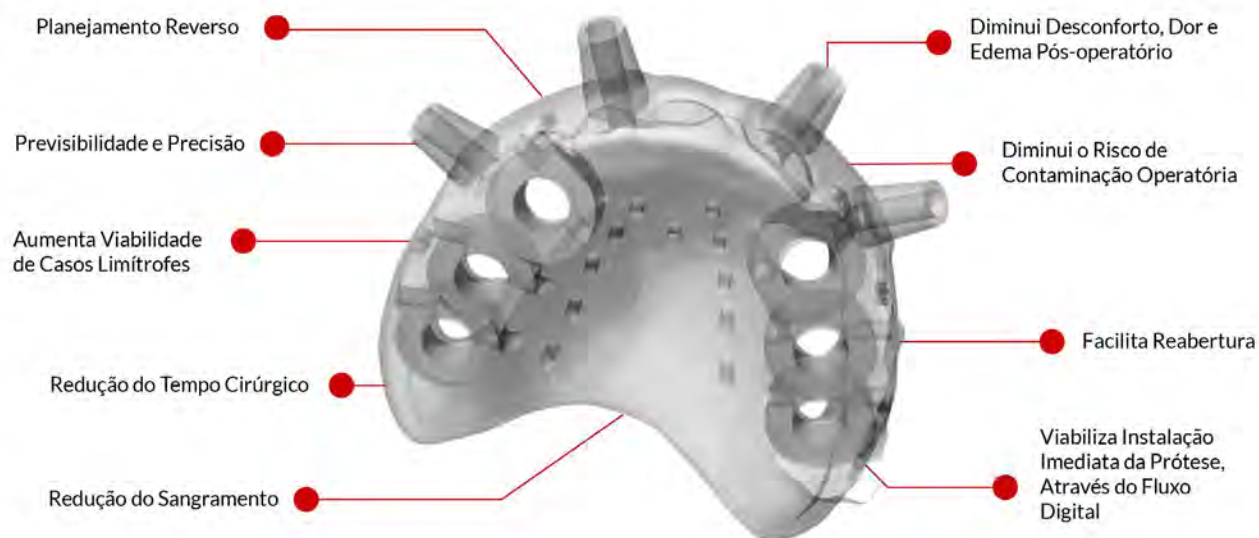





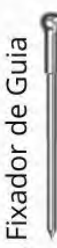











VANTAGENS DA CIRURGIA GUIADA



GUIA PARA MONTAGEM

Kit Supreme Guided

1. Broca 
2. Fixador de Guia 
3. Estabilizador de Guia CM 
4. Estabilizador de Guia HI-HE 
5. Punch 
6. Broca lança 
7. Broca escalonada 
8. Broca Supreme Ø3,50 - 8,5-10 
9. Broca Supreme Ø3,50 - 11,5-13 
10. Broca piloto Ø2,8 - 3,5 
11. Broca Supreme Ø3,75 - 8,5-10 
12. Broca Supreme Ø3,75 - 11,5-13 
13. Broca piloto Ø3,0 - 3,75 
14. Chave de captura p/ C.A. CM 
15. Chave de captura p/ C.A. HE 
16. Chave de captura p/ C.A. HI 
17. Chave de torque CM 
18. Chave de torque HE 
19. Chave de torque HI 
20. Chave hexagonal 1,2mm 
21. Chave quadrada longa 1,3mm 
22. Cabo digital para chave torque 



GUIA PARA MONTAGEM

Kit Supreme Guided

23. Sonda calibrada para cirurgia guiada



24. Chave de torque

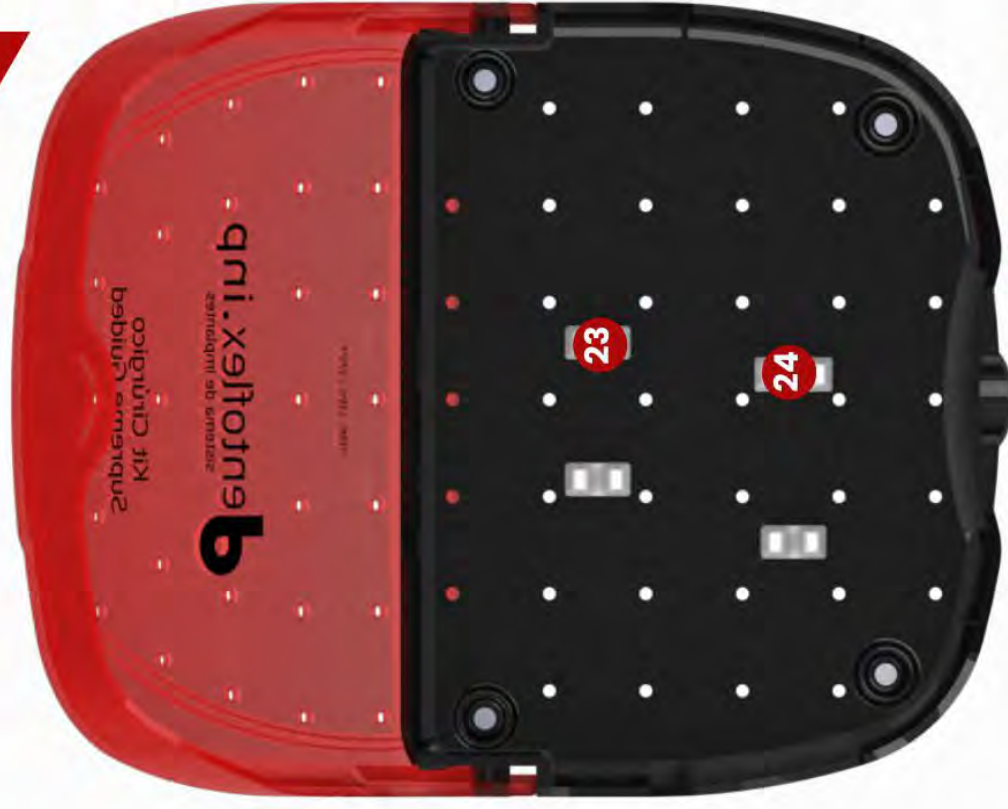

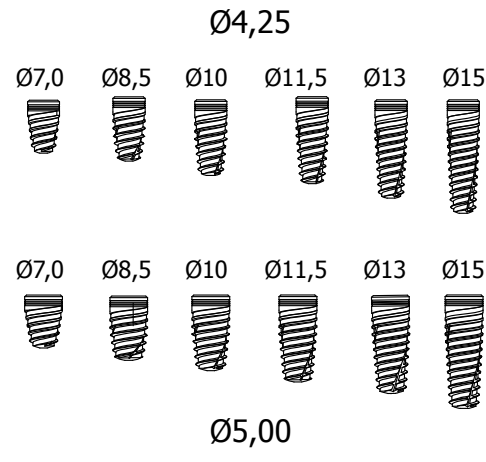
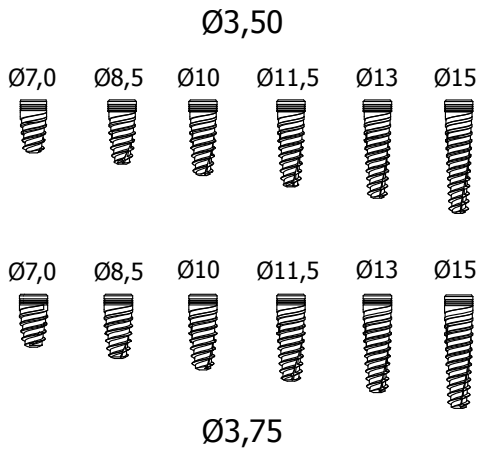

Supreme HI/Cone Morse

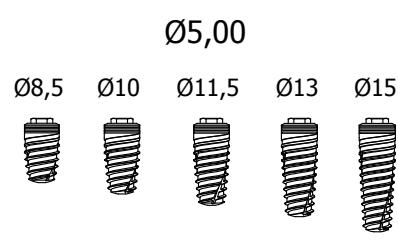
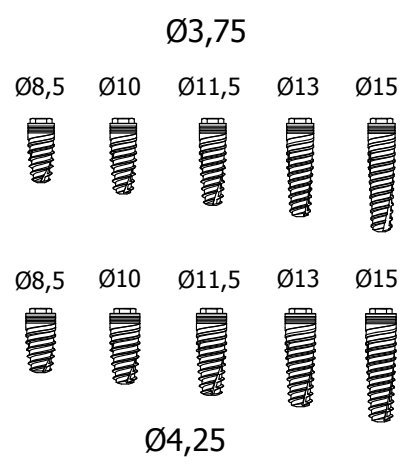
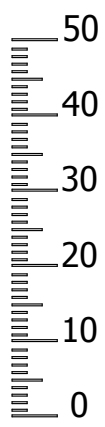

Supreme Hexágono Externo

Ampliação de 30%

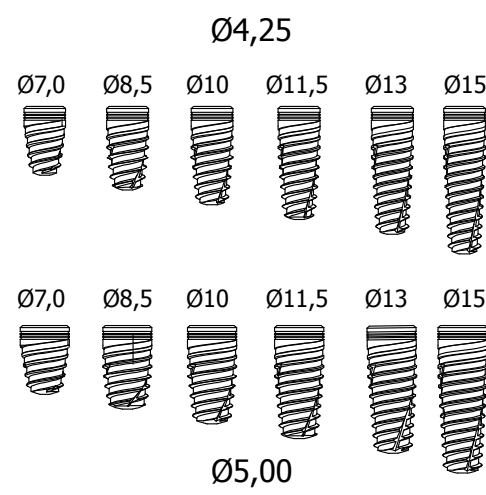
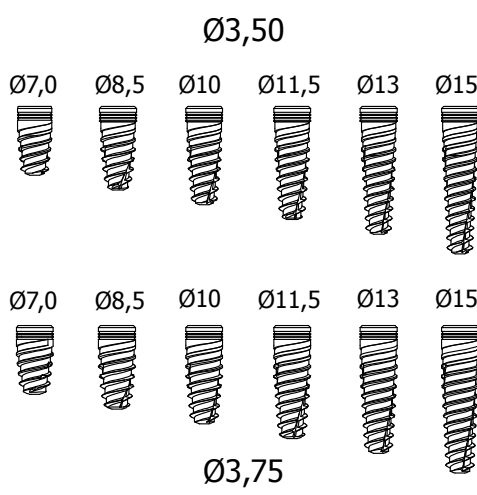

Supreme HI/Cone Morse

Ampliação de 30%

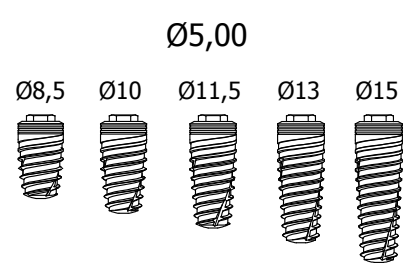
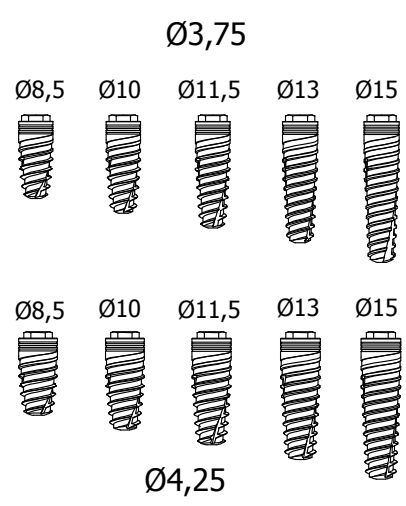

Supreme Hexágono Externo

Search

Brocas

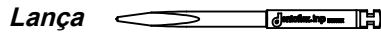

Supreme

Brocas

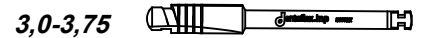
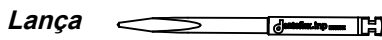

Z.FORCE

Zygomatic

Brocas

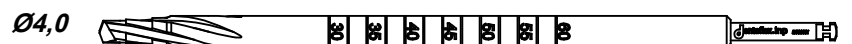
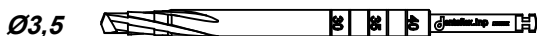
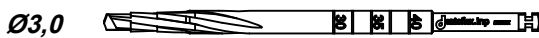
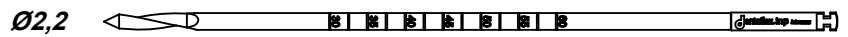
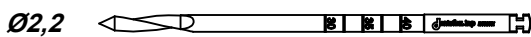



🌐 dentoflex.com.br
✉ sac@inp-dentoflex.com
☎ Tel.: 55 11 2083 - 4130
📞 WhatsApp: +55 11 99589-8239

