

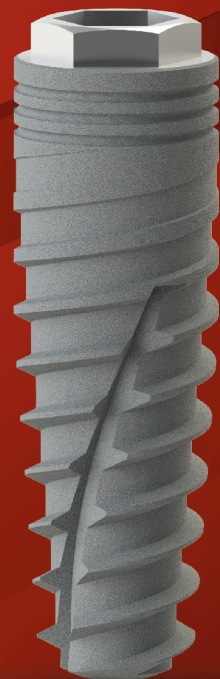

dentoflex.inp  
sistema de implantes

**CATÁLOGO DE PRODUTOS  
2026**

# *Supreme*

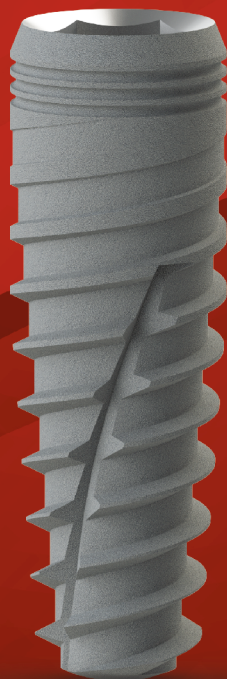
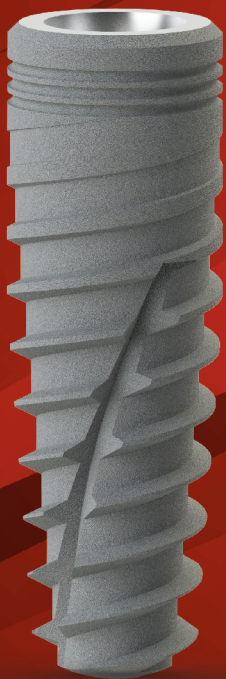

## O MAIS RECOMENDADO PELOS ESPECIALISTAS

A conexão morse veio como uma evolução aos implantes HE e HI, que são usados até hoje. Superior quanto à adaptação da parte protética, com um encaixe perfeito da interface. Tem vantagens, não somente o selamento biológico da conexão, mas também biomecanicamente e esteticamente, e apresenta maior dinamismo nos procedimentos.

### CARACTERÍSTICAS:

Produzido em Titânio ASTM F67 Grau IV  
Corpo cônico, rosca dupla  
Apresenta cone de 11,5° e rosca 1,8 mm  
Plataforma Switch  
Alta estabilidade inicial

Indicado para colocação na profundidade de 1, 2 e 3mm

Acompanha tapa implante

Recomendado para osso tipo I, II, III e IV. \*Verificar sequência de brocas.

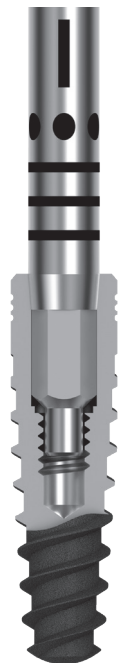

### CHAVES DE CAPTURA E INSTALAÇÃO DO IMPLANTE



Disponível nos tamanhos  
Curto e Longo

Descrição	Código
Chave Catraca Curta	55882
Chave Catraca Longa	55883
Chave C.A Curta	55834

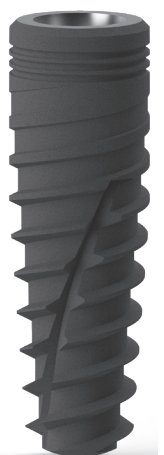

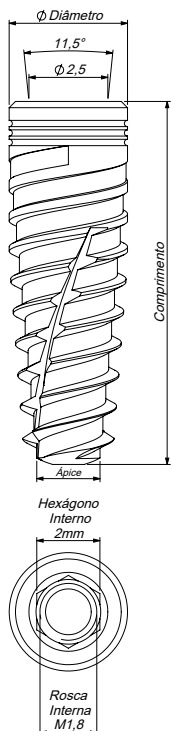

**Diâmetro**

**Comprimentos**

Ø 3,50	7,0 mm 60248	8,50 mm 56823	10,0 mm 56819	11,5 mm 56820	13,0 mm 56821	15,0 mm 56822
Ø 3,75	7,0 mm 60249	8,50 mm 56828	10,0 mm 56824	11,5 mm 56825	13,0 mm 56826	15,0 mm 56827
Ø 4,25	7,0 mm 60250	8,50 mm 56833	10,0 mm 56829	11,5 mm 56830	13,0 mm 56831	15,0 mm 56832
Ø 5,00	7,0 mm 60251	8,50 mm 56838	10,0 mm 56834	11,5 mm 56835	13,0 mm 56836	15,0 mm 56837

**Sequência de Brocas**

Implante	Lança	Supreme 3,5	Piloto Supreme 2,8 / 3,5	Supreme 3,75	Piloto Supreme 3,0 / 3,75	Supreme 4,25	Piloto Supreme 3,60 / 4,25	Supreme 5,00	Piloto Supreme 4,25 / 5,00
3,50 mm	●	●	○						
3,75 mm	●	●		●	○				
4,25 mm	●	●		●		●	○		
5,00 mm	●	●		●		●		●	○

○ Para osso tipo I e II

● Para osso tipo III e IV

**TAPA IMPLANTE**



1,0 mm

56839

**CICATRIZADORES**



Ø 3,30mm

0,8 mm	56152
1,5 mm	56153
2,5 mm	56154
3,5 mm	56155
4,5 mm	56253
5,5 mm	56254



Ø 4,50mm

0,8 mm	56256
1,5 mm	56257
2,5 mm	56258
3,5 mm	56259
4,5 mm	56260
5,5 mm	56261

**TRANSFER MOLDEIRA ABERTA**



57940

- ✓ Modelo único com index
- ✓ Produzido em Aço Inox

**TRANSFER MOLDEIRA FECHADA**



57864

- ✓ Modelo único com index
- ✓ Produzido em Aço Inox

**ANÁLOGO DO IMPLANTE**



56116

- ✓ Produzido em Aço Inox

**MUNHÃO UNIVERSAL CONE MORSE**



20  
N.cm



- ✓ Disponível sem index
- ✓ Produzido em Titânio

**MUNHÃO UNIVERSAL - SEM Index**

Ø 3,30	4,0 mm	0,8 mm	58047
	4,0 mm	1,5 mm	58048
	4,0 mm	2,5 mm	58049
	4,0 mm	3,5 mm	58050
	4,0 mm	4,5 mm	58051
	4,0 mm	5,5 mm	58052
	6,0 mm	0,8 mm	58054
	6,0 mm	1,5 mm	58055
	6,0 mm	2,5 mm	58056
	6,0 mm	3,5 mm	58057
Ø 4,50	6,0 mm	4,5 mm	58058
	6,0 mm	5,5 mm	58059
	4,0 mm	0,8 mm	58061
	4,0 mm	1,5 mm	58095
	4,0 mm	2,5 mm	58096
	4,0 mm	3,5 mm	58097
	4,0 mm	4,5 mm	58098
	4,0 mm	5,5 mm	58099
	6,0 mm	0,8 mm	58101
	6,0 mm	1,5 mm	58102
6,0 mm	2,5 mm	58103	
6,0 mm	3,5 mm	58104	
6,0 mm	4,5 mm	58105	
6,0 mm	5,5 mm	58106	

**MUNHÃO UNIVERSAL ANGULADO - COM Index**



15  
N.cm



- ✓ Disponível com index
- ✓ Produzido em Titânio

Ø 3,30	4,0 mm	17°	1,5 mm	56200
	4,0 mm	17°	3,5 mm	56206
	4,0 mm	30°	1,5 mm	56202
	4,0 mm	30°	3,5 mm	56208
	6,0 mm	17°	1,5 mm	56209
	6,0 mm	17°	3,5 mm	56215
	6,0 mm	30°	1,5 mm	56211
	6,0 mm	30°	3,5 mm	56217

Ø 4,50	4,0 mm	17°	1,5 mm	56218
	4,0 mm	17°	3,5 mm	57111
	4,0 mm	30°	1,5 mm	56319
	4,0 mm	30°	3,5 mm	57113
	6,0 mm	17°	1,5 mm	57114
	6,0 mm	17°	3,5 mm	57120
	6,0 mm	30°	1,5 mm	57116
	6,0 mm	30°	3,5 mm	57122

### ANÁLOGO DO MUNHÃO UNIVERSAL



Ø 3,30	4,0 mm	56112
	6,0 mm	56113
Ø 4,50	4,0 mm	56114
	6,0 mm	56115

### TRANSFER DO MUNHÃO UNIVERSAL

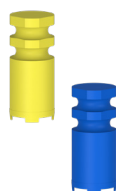

Ø 3,30	4,0 mm	Amarelo	57960
	6,0 mm	Azul	57961
Ø 4,50	4,0 mm	Amarelo	57962
	6,0 mm	Azul	57996

### COIFA DO MUNHÃO UNIVERSAL

Calcinável  
Antirrotacional



Temporária  
Antirrotacional

Ø 3,30	4,0 mm	57173
	6,0 mm	57141
Ø 4,50	4,0 mm	57142
	6,0 mm	57143

Ø 3,30	4,0 mm	57144
	6,0 mm	57145
Ø 4,50	4,0 mm	57146
	6,0 mm	57147

### UCLA CINTA METÁLICA CONE MORSE



0,8 mm	58028
1,5 mm	58063
2,5 mm	58065
3,5 mm	58067
4,5 mm	58069

✓ Cinta produzida em Cr-Co

### MUNHÃO PROVISÓRIO CONE MORSE

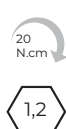

0,8 mm	58180
1,5 mm	58181
2,5 mm	58182
3,5 mm	58183
4,5 mm	58184

✓ Produzido em Titânio

### ACESSÓRIOS



Parafuso p/ UCLA cinta metálica CM

58094

PILAR FLEX CONE MORSE



CINTA	CÓDIGOS
0,8 mm	57383
1,5 mm	57384
2,5 mm	57385
3,5 mm	57386
4,5 mm	57387
5,5 mm	57388

- ✓ Produzido em titânio
- ✓ Rosca de 2,0mm maior resistência
- ✓ Distância oclusal mínima: 6,5mm
- ✓ Parafusada unitária e múltipla

CAPA DE PROTEÇÃO



56151

- ✓ Modelo único
- ✓ Produzido em Titânio

ANÁLOGO



AR 56096

- ✓ Produzido em Aço Inox

TRANSFER MOLDEIRA ABERTA



57952

- ✓ Produzido em Aço Inox

TRANSFER MOLDEIRA FECHADA



59550

- ✓ Produzido em Aço Inox

LUVA METÁLICA



AR	57396
Circular	57398

- ✓ Disponível AR e Circular
- ✓ Produzido em Titânio

LUVA CINTA METÁLICA



AR	57391
Circular	57394

- ✓ Disponível AR e Circular
- ✓ Cinta produzida em Cr-Co

LUVA PLÁSTICA



AR	57389
Circular	57393

- ✓ Disponível AR e Circular
- ✓ Produzido em Poliacetal

ACESSÓRIOS



Parafuso p/ munhão flex

58389

### OVERDENTURE / SISTEMA O'RING

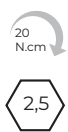

CINTA	CÓDIGOS
0,8 mm	58344
1,5 mm	58345
2,5 mm	58346
3,5 mm	58347
4,5 mm	58348
5,5 mm	58349

- ✓ Acompanha cápsula de titânio e arruela espaçadora
- ✓ Produzido em Titânio

### O'RING FUNDÍVEL



- ✓ Utilizado em raiz natural ou em posição distal da barra-clip
- ✓ Acompanha cápsula de titânio e arruela espaçadora
- ✓ Produzido em Poliacetal

58350



#### CÁPSULA METÁLICA

58279

- ✓ Produzido em Titânio



#### ARRUELA ESPAÇADORA

55341

- ✓ Produzido em Poliacetal
- c/10 unidades



#### ANEL O'RING 10 und.

56227

- ✓ Produzido em Borracha

### CONJUNTO BARRA CLIP

59246	BARRA
56660	CLIP 35°
56661	CLIP 70°
56662	CLIP RETO

- ✓ Indicado para uso em Implantes com distância mínima de 22 mm
- ✓ Produzido em Poliacetal

\*Embalagem com 2 peças.

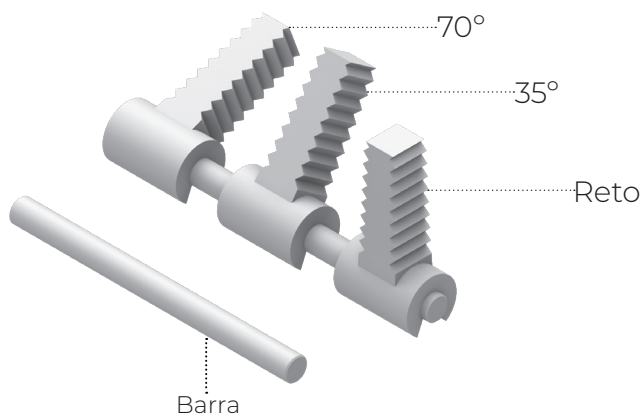

## MIRUSCONE ANGULADO CONE MORSE



1,5 mm	17°	57925
2,5 mm	17°	57928
3,5 mm	17°	57964
1,5 mm	30°	57927
2,5 mm	30°	57963
3,5 mm	30°	57966

- ✓ Produzido em Titânio
- ✓ Com Index
- ✓ Com parafuso passante
- ✓ Não deve ser usado para unitário
- ✓ Com transportador metálico
- ✓ Indicado para prótese Multipla e Total

## ACESSÓRIOS



Parafuso p/ miruscone angulado CM 58375

## MIRUSCONE RETO CONE MORSE



0,8 mm	57910
1,5 mm	57911
2,5 mm	57915
3,5 mm	57919
4,5 mm	57923
5,5 mm	57924

- ✓ Produzido em Titânio
- ✓ Distância oclusal mínima: 4,5mm
- ✓ Não deve ser usado para unitário
- ✓ Com transportador plástico
- ✓ Indicado para prótese Multipla e Total

### CAPA DE PROTEÇÃO PARA MIRUSCONE



53944

- ✓ Modelo único
- ✓ Produzido em Titânio

### ANÁLOGO



56111

- ✓ Modelo único
- ✓ Produzido em Aço Inox

### TRANSFER MOLDEIRA ABERTA



57959

- ✓ Modelo único
- ✓ Produzido em Aço Inox

### TRANSFER MOLDEIRA FECHADA



58575

- ✓ Modelo único
- ✓ Produzido em Aço Inox

### LUVA METÁLICA



57903

- ✓ Modelo único
- ✓ Produzido em Titânio

### LUVA CINTA METÁLICA



57907

- ✓ Modelo único
- ✓ Cinta produzida em Cr-Co

### LUVA PLÁSTICA



55343

- ✓ Modelo único
- ✓ Produzido em Poliacetal

### ACESSÓRIOS



Micro parafuso para miruscone

58382

# Supreme

Hexágono Interno

## ESTABILIDADE DE CONEXÃO

Corpo cônico os implantes hexágono interno conseguem alcançar uma boa estabilidade primária e são compatíveis com todos os tipos ósseos, mesmo em casos de osso não compactado. Pode ser utilizado em qualquer tipo de restauração protética, aparafusada e cimentada.

## CARACTERÍSTICAS:

Produzido em Titânio ASTM F67 Grau IV

Corpo cônico, rosca dupla

Plataforma Switch

Hexágono Interno 2,50 mm

Rosca interna de 2,00 mm

Alta estabilidade inicial

Acompanha tampa implante

Recomendado para osso tipo I, II, III e IV. \*Verificar sequência de brocas.

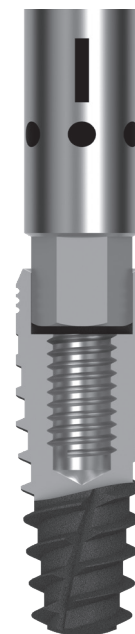

## CHAVE DE CAPTURA E INSTALAÇÃO



Disponível nos tamanhos  
Curto e Longo

Chaves para captura do  
Implante, finalização deverá ser  
com intermediário para catraca.

Descrição	Código
Intermediário Catraca Curta	57755
Intermediário Catraca Longa	57756
Chave C.A Curta	57753

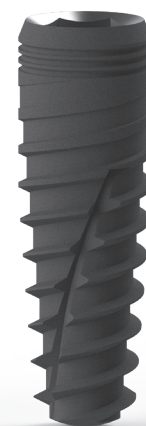

**Diâmetro**

**Comprimentos**

Ø 3,50	7,0 mm 60256	8,50 mm 56955	10,0 mm 56951	11,5 mm 56952	13,0 mm 56953	15,0 mm 56954
Ø 3,75	7,0 mm 60257	8,50 mm 56960	10,0 mm 56956	11,5 mm 56957	13,0 mm 56958	15,0 mm 56959
Ø 4,25	7,0 mm 60258	8,50 mm 56965	10,0 mm 56961	11,5 mm 56962	13,0 mm 56963	15,0 mm 56964
Ø 5,00	7,0 mm 60259	8,50 mm 56970	10,0 mm 56966	11,5 mm 56967	13,0 mm 56968	15,0 mm 56969

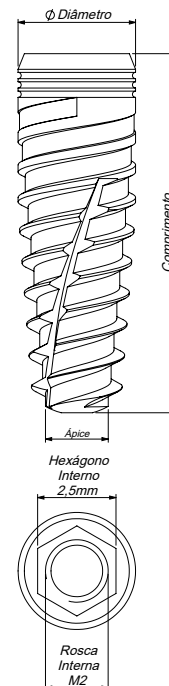

**Sequência de Brocas**

Switch	Implante	Lança	Supreme 3,5	Piloto Supreme 2,8 / 3,5	Supreme 3,75	Piloto Supreme 3,0 / 3,75	Supreme 4,30	Piloto Supreme 3,60 / 4,30	Supreme 5,00	Piloto Supreme 4,30 / 5,00
3,25 mm	3,50 mm	●	●	○						
3,25 mm	3,75 mm	●	●		●	○				
3,75 mm	4,25 mm	●	●		●		●	○		
4,25 mm	5,00 mm	●	●		●		●		●	○

○ Para osso tipo I e II

● Para osso tipo III e IV

**CICATRIZADORES**



3,75 mm	3,0 mm	57816
	5,0 mm	57817
	7,0 mm	57818
4,25 mm	3,0 mm	57822
	5,0 mm	57823
	7,0 mm	57824

3,75 m	3,0 mm	5,0 mm	56012
	5,0 mm	5,0 mm	56015
4,25 mm	3,0 mm	5,0 mm	56128
	5,0 mm	5,0 mm	56131

**ANÁLOGO DO IMPLANTE**



Ø 3,25	56103
Ø 3,75	56105
Ø 4,25	56107

✓ Produzido em Aço Inox

**TRANSFER MOLDEIRA ABERTA**



57938

- ✓ Modelo único para todos os diâmetros
- ✓ Altura única
- ✓ Produzido em Aço Inox

**TRANSFER MOLDEIRA FECHADA**



58569

- ✓ Altura única
- ✓ Produzido em Aço Inox

**UCLA CINTA METÁLICA AR E CIRCULAR**



1,3

	AR	CIRCULAR
Ø 3,75	58134	58089
Ø 4,25	58136	58091

- ✓ Disponível em dois diâmetros
- ✓ Altura única
- ✓ Cinta produzida em Cr-Co

**UCLA PLÁSTICA AR E CIRCULAR**



1,3

	AR	CIRCULAR
Ø 3,75	58009	55303
Ø 4,25	58011	58023

- ✓ Disponível em dois diâmetros
- ✓ Altura única
- ✓ Produzido em Poliacetal

## MUNHÃO ANGULADO



- ✓ Disponível em dois diâmetros
- ✓ Produzido em Titânio

Ø 3,75	1,0 mm	15°	56865
	2,0 mm	15°	56867
	3,0 mm	15°	56869
	1,0 mm	25°	56872
	2,0 mm	25°	56874
	3,0 mm	25°	56876
	1,0 mm	35°	57240
	2,0 mm	35°	57242
	3,0 mm	35°	57244
Ø 4,25	1,0 mm	15°	57257
	2,0 mm	15°	57259
	3,0 mm	15°	57260
	1,0 mm	25°	57262
	2,0 mm	25°	57264
	3,0 mm	25°	57265
	1,0 mm	35°	57267
	2,0 mm	35°	57269
	3,0 mm	35°	57271

## MUNHÃO TEMPORÁRIO CIRCULAR

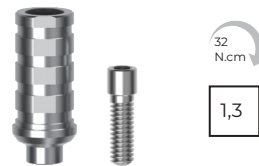

- ✓ Disponível em dois diâmetros
- ✓ Altura única
- ✓ Produzido em Titânio

Ø 3,75	58262
Ø 4,25	58264

## MUNHÃO PARA PRÓTESE CIMENTADA



- ✓ Disponível em dois diâmetros
- ✓ Produzido em Titânio

Ø 3,75	1,0 mm	56597
	2,0 mm	56598
	3,0 mm	56599
Ø 4,25	1,0 mm	56606
	2,0 mm	56607
	3,0 mm	56608

## MUNHÃO TEMPORÁRIO AR



Ø 3,75	58251
Ø 4,25	58253

- ✓ Disponível em dois diâmetros
- ✓ Altura única
- ✓ Produzido em Titânio

## ACESSÓRIOS



Parafuso do componente protético 55394

### MIRUSCONE ANGULADO

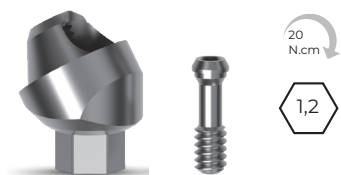

- ✓ Produzido em Titânio
- ✓ Distância oclusal mínima: 4,5mm
- ✓ Com transportador metálico
- ✓ Indicado para prótese Múltipla e Total

Ø 3,75	1,0 mm	17°	56725
	2,0 mm	17°	56727
	3,0 mm	17°	56729
	1,0 mm	30°	56739
	2,0 mm	30°	56741
	3,0 mm	30°	56743

### ACESSÓRIOS



Parafuso p/ miruscone angulado HI

59576

### MIRUSCONE RETO



- ✓ Produzido em Titânio
- ✓ Distância oclusal mínima: 4,5mm
- ✓ Não deve ser usado para unitário
- ✓ Com transportador plástico
- ✓ Indicado para prótese múltipla e total

Ø 3,75	1,0 mm	56723
	2,0 mm	56730
	3,0 mm	56737
Ø 4,25	1,0 mm	58512
	2,0 mm	58513
	3,0 mm	58514

**CAPA DE PROTEÇÃO PARA MIRUSCONE**



53944

- ✓ Modelo único
- ✓ Produzido em Titânio

**ANÁLOGO**



56111

- ✓ Modelo único
- ✓ Produzido em Aço Inox

**TRANSFER MOLDEIRA ABERTA**



57959

- ✓ Modelo único
- ✓ Produzido em Aço Inox

**TRANSFER MOLDEIRA FECHADA**



58575

- ✓ Modelo único
- ✓ Produzido em Aço Inox

**LUVA METÁLICA**



57903

- ✓ Modelo único
- ✓ Produzido em Titânio

**LUVA PLÁSTICA**



55343

- ✓ Modelo único
- ✓ Produzido em Poliacetal

**LUVA CINTA METÁLICA**



57907

- ✓ Modelo único
- ✓ Cinta produzida em Cr-Co

**ACESSÓRIOS**

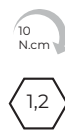

Micro parafuso para miruscone

58382

**OVERDENTURE**



Ø 3,25	1,0 mm	58297
	2,0 mm	58298
	3,0 mm	58299
	4,0 mm	58300
	5,0 mm	58301
Ø 3,75	1,0 mm	58309
	2,0 mm	58311
	3,0 mm	58312
Ø 4,25	4,0 mm	58313
	5,0 mm	58314
	1,0 mm	58322
	2,0 mm	58323
	3,0 mm	58324
	4,0 mm	58325
	5,0 mm	58326

- ✓ Acompanha cápsula de titânio e arruela espaçadora
- ✓ Produzido em Titânio

**O'RING FUNDÍVEL**



- ✓ Utilizado em raiz natural ou em posição distal da barra-clip
- ✓ Acompanha cápsula de titânio e arruela espaçadora
- ✓ Produzido em Poliacetal

58350



**CÁPSULA METÁLICA**

58279

- ✓ Produzido em Titânio



**ARRUELA ESPAÇADORA**

55341

- ✓ Produzido em Poliacetal
- c/10 unidades



**ANEL O'RING 10 und.**

56227

- ✓ Produzido em Borracha

**CONJUNTO BARRA CLIP**

59246	BARRA
56660	CLIP 35°
56661	CLIP 70°
56662	CLIP RETO

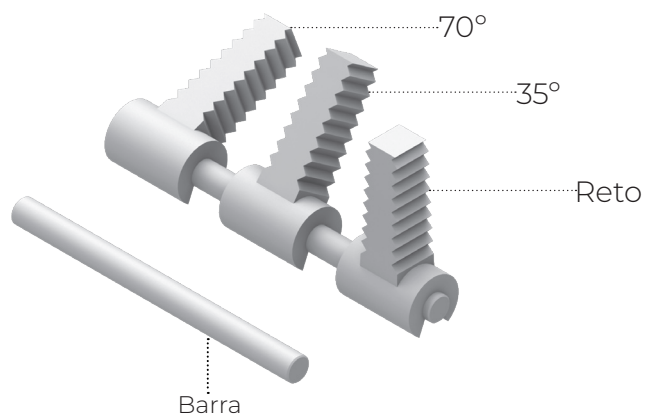

- ✓ Indicado para uso em Implantes com distância mínima de 22 mm
- ✓ Produzido em Poliacetal
- \*Embalagem com 2 peças.

# Supreme

Hexágono Externo

## UMA BOA ALTERNATIVA PARA REABILITAÇÃO DENTÁRIA

Os implantes hexágono externo atendem todos os tipos de reabilitações protéticas, sendo possível ser feito com carga imediata ou precoce. Seu sistema abrange uma grande variedade de componentes protéticos o que facilita a escolha da solução adequada para cada paciente.

### CARACTERÍSTICAS:

Produzido em Titânio ASTM F67 Grau IV

Corpo cônico, rosca dupla

Plataforma Switch

Hexágono Externo 2,70 mm

Altura do hexágono 0,70 mm

Rosca interna de 2,00 mm

Alta estabilidade inicial

Acompanha tampa implante

Recomendado para osso tipo I, II, III e IV. \*Verificar sequência de brocas.

Torque Interno

### CHAVES DE CAPTURA E INSTALAÇÃO DO IMPLANTE



Disponível nos tamanhos Curto e Longo

Chaves para captura do Implante, finalização deverá ser com intermediário para catraca.

Descrição	Código
Chave Catraca Curta	55882
Chave Catraca Longa	55883
Chave C.A Curta	55851

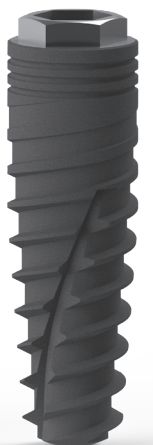
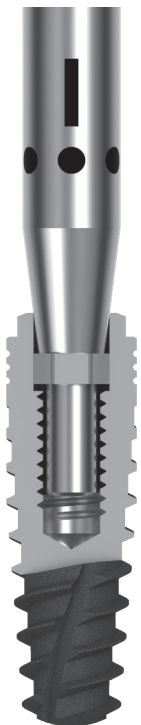

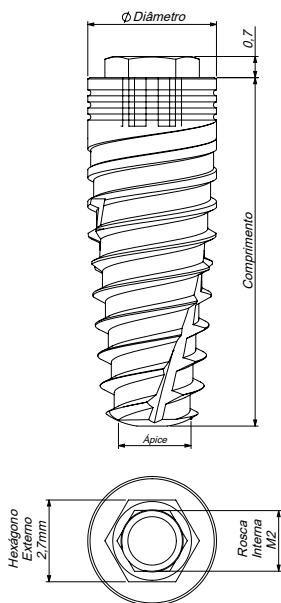

**Diâmetro**

**Comprimentos**

Ø 3,75	8,50 mm 57079	10,0 mm 57075	11,5 mm 57076	13,0 mm 57077	15,0 mm 57078
Ø 4,25	8,50 mm 57084	10,0 mm 57080	11,5 mm 57081	13,0 mm 57082	15,0 mm 57083
Ø 5,00	8,50 mm 57089	10,0 mm 57085	11,5 mm 57086	13,0 mm 57087	15,0 mm 57088

**Sequência de Brocas**

Implante	Lança	Supreme 3,5	Piloto Supreme 2,8 / 3,5	Supreme 3,75	Piloto Supreme 3,0 / 3,75	Supreme 4,30	Piloto Supreme 3,60 / 4,30	Supreme 5,00	Piloto Supreme 4,30 / 5,00
3,75 mm	●	●		●	○				
4,25 mm	●	●		●		●	○		
5,00 mm	●	●		●		●		●	○

○ Para osso tipo I e II

● Para osso tipo III e IV

**CICATRIZADORES**



07635	CICATRIZADOR W 4,1 X 3,0 X 5,4
01280	CICATRIZADOR W 4,1 X 4,0 X 5,4
07638	CICATRIZADOR W 4,1 X 6,0 X 5,4

07518	CICATRIZADOR PARALELO 4,1 X 3,0
07519	CICATRIZADOR PARALELO 4,1 X 4,0
07521	CICATRIZADOR PARALELO 4,1 X 6,0

**TRANSFER MOLDEIRA ABERTA**



55345

- ✓ Modelo único para todos os diâmetros
- ✓ Produzido em Aço Inox

**TRANSFER MOLDEIRA FECHADA**



58565

- ✓ Modelo único para todos os diâmetros
- ✓ Produzido em Aço Inox

**ANÁLOGO DO IMPLANTE**



Ø 3,75

56100

- ✓ Produzido em Aço Inox

**UCLA CINTA METÁLICA AR E CIRCULAR**



1,3

	AR	CIRCULAR
Ø 3,75	58129	58084

- ✓ Altura única
- ✓ Cinta produzida em Cr-Co

**UCLA PLÁSTICA AR E CIRCULAR**



1,3

	AR	CIRCULAR
Ø 3,75	58003	58016

- ✓ Altura única
- ✓ Produzido em Poliacetal

MUNHÃO ANGULADO



Ø 3,75	1,0 mm	15°	56451
	2,0 mm	15°	56452
	3,0 mm	15°	56453
	1,0 mm	25°	56455
	2,0 mm	25°	56456
	3,0 mm	25°	56457
	1,0 mm	35°	56459
	2,0 mm	35°	56460
	3,0 mm	35°	56461

✓ Produzido em Titânio

MUNHÃO TEMPORÁRIO AR



Ø 3,75	58247
--------	-------

✓ Produzido em Titânio

MUNHÃO TEMPORÁRIO CIRCULAR



Ø 3,75	58258
--------	-------

✓ Produzido em Titânio

MUNHÃO PARA PRÓTESE CIMENTADA



Ø 3,75	1,0 mm	56582
	2,0 mm	56583
	3,0 mm	56584

✓ Produzido em Titânio

ACESSÓRIOS

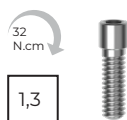

Parafuso do componente protético

55394

## MIRUSCONE ANGULADO



Ø 3,75	1,0 mm	17°	57796
	2,0 mm	17°	57797
	3,0 mm	17°	56320
	1,0 mm	30°	56325
	2,0 mm	30°	56326
	3,0 mm	30°	56327

- ✓ Produzido em Titânio
- ✓ Distância oclusal mínima: 4,5mm
- ✓ Com transportador metálico
- ✓ Indicado para prótese múltipla e total

## ACESSÓRIOS

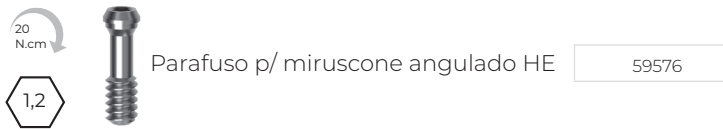

## MIRUSCONE RETO



Ø 3,75	1,0 mm	57795
	2,0 mm	56322
	3,0 mm	56324

- ✓ Produzido em Titânio
- ✓ Distância oclusal mínima: 4,5mm
- ✓ Com transportador plástico
- ✓ Indicado para prótese múltipla e total

### CAPA DE PROTEÇÃO PARA MIRUSCONE



53944

- ✓ Modelo único
- ✓ Produzido em Titânio

### ANÁLOGO



56111

- ✓ Modelo único
- ✓ Produzido em Aço Inox

### TRANSFER MOLDEIRA ABERTA



57959

- ✓ Modelo único
- ✓ Produzido em Aço Inox

### TRANSFER MOLDEIRA FECHADA



58575

- ✓ Modelo único
- ✓ Produzido em Aço Inox

### LUVA METÁLICA



57903

- ✓ Modelo único
- ✓ Produzido em Titânio

### LUVA PLÁSTICA



55343

- ✓ Modelo único
- ✓ Produzido em Poliacetal

### LUVA CINTA METÁLICA



57907

- ✓ Modelo único
- ✓ Cinta produzida em Cr-Co

### ACESSÓRIOS



Micro parafuso para miruscone

58382

**OVERDENTURE / SISTEMA O'RING**



✓ Acompanha cápsula de titânio e arruela espaçadora

✓ Produzido em Titânio

Ø 3,75	1,0 mm	58287
	2,0 mm	58289
	3,0 mm	58290
	4,0 mm	58292
	5,0 mm	58293

**O'RING FUNDÍVEL**



✓ Utilizado em raiz natural ou em posição distal da barra-clip

✓ Acompanha cápsula de titânio e arruela espaçadora

✓ Produzido em Poliacetal

58350



**CÁPSULA METÁLICA**

58279

✓ Produzido em Titânio



**ARRUELA ESPAÇADORA**

55341

✓ Produzido em Poliacetal  
c/ 10 unidades



**ANEL O'RING 10 und.**

56227

✓ Produzido em Borracha

**CONJUNTO BARRA CLIP**

59246	BARRA
56660	CLIP 35°
56661	CLIP 70°
56662	CLIP RETO

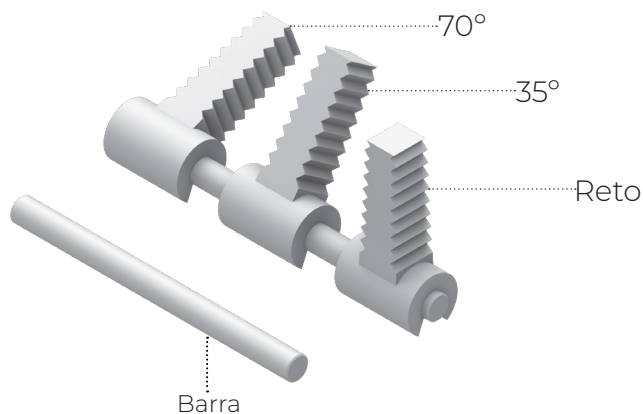

✓ Indicado para uso em Implantes com distância mínima de 22 mm

✓ Produzido em Poliacetal

\*Embalagem com 2 peças.

# Kit Cirúrgico

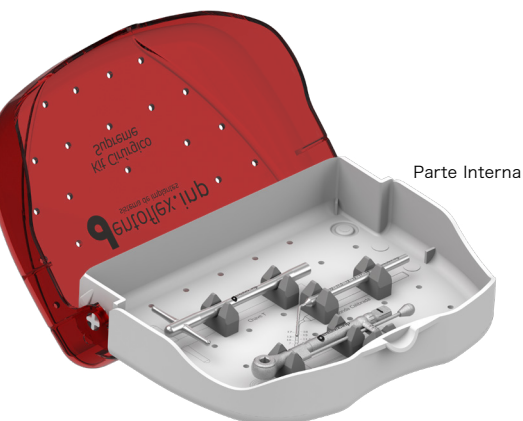
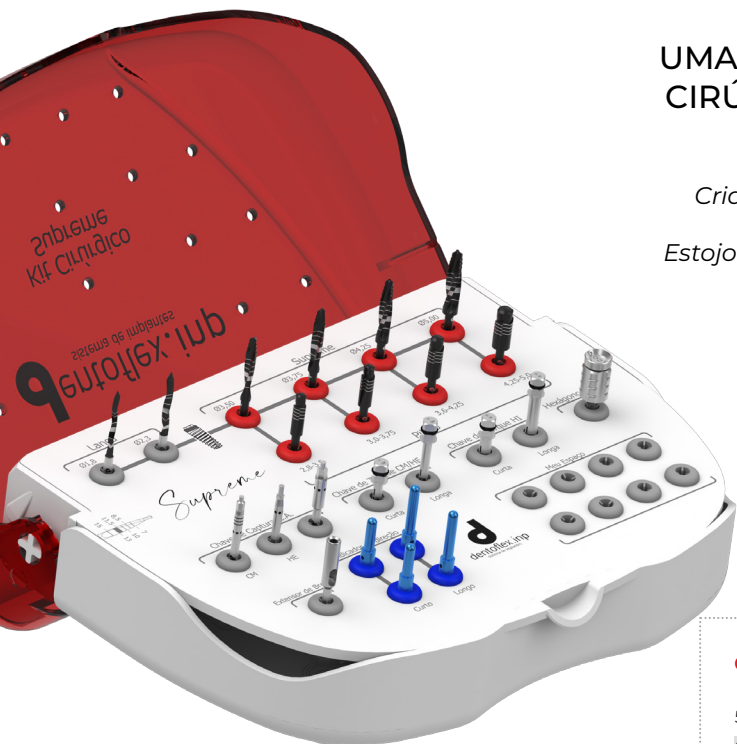

Parte Interna

PARA USO EM TODA

*Linha Supreme*

CONE MORSE / HE / HI

**UMA DAS PRINCIPAIS VANTAGENS DO KIT CIRÚRGICO É QUE ELE PODE SER USADO EM TODA A LINHA SUPREME**

*Criado especialmente para garantir a eficiência na dinâmica do seu consultório. Estoque leve e de fácil manuseio, torna também o kit mais versátil e prático.*

07739

ESTOJO KIT CIRÚRGICO

## COMPONENTES

Cod.	Descrição	Qtd.
59926	BROCA LANÇA	1
55750	BROCA LANÇA TRI-HELICOIDAL Ø2,30	1
56880	BROCA PILOTO SUPREME 2,8-3,5	1
55729	BROCA SUPREME Ø3,50	1
56881	BROCA PILOTO SUPREME 3,0-3,75	1
55731	BROCA SUPREME Ø3,75	1
56882	BROCA PILOTO SUPREME 3,6-425	1
55738	BROCA SUPREME Ø4,25	1
56883	BROCA PILOTO SUPREME 4,25-5,0	1
56879	BROCA SUPREME Ø5,00	1
55834	CHAVE CURTA P/ IMPL. O.C. C.M. P/ C.A.	1
55882	CHAVE CURTA P/ IMPL. O.C. C.M. P/ CATRACA	1
55851	CHAVE CURTA P/ IMPL. T.I. P/ C.A.	1
08877	CHAVE DE TORQUE	1
01379	CHAVE DIGITAL HEXAGONAL MÉDIA	1
55883	CHAVE LONGA P/ IMPL. O.C. C.M. P/ CATRACA	1
01393	CHAVE T FIXA	1
06821	EXTENSOR DE BROCA	1
57750	INDICADOR DE DIREÇÃO CURTO ACESS. P/ IMPL.	2
57751	INDICADOR DE DIREÇÃO LONGO ACESS. P/ IMPL.	2
57753	INTERMEDIÁRIO CURTO P/ C.A. P/ IMPL. HI	1
57755	INTERMEDIÁRIO P/ CATRACA CURTO P/ IMPL. HI	1
57756	INTERMEDIÁRIO P/ CATRACA LONGO P/ IMPL. HI	1
55832	SONDA CALIBRADA P/ IMPLANTE	1

**Kit único e versátil: evite volume, priorize a qualidade, funcionalidade, e a eficiência no seu dia a dia.**

Mais eficiência para maximização de resultados

Menos materiais para manusear

Número reduzido de erros ou enganos

Menor ocupação do espaço físico

Mais agilidade nos procedimentos

\*Imagens meramente ilustrativas. Os estojos podem apresentar variações de cor e design.

## BROCAS

59926 

BROCA LANÇA

55750 

BROCA LANÇA TRI-HELICOIDAL Ø2,30

56880 

BROCA PILOTO SUPREME 2,8-3,5

56881 

BROCA PILOTO SUPREME 3,0-3,75

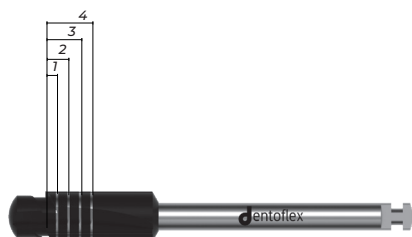
56882 

BROCA PILOTO SUPREME 3,6-4,25

56883 

BROCA PILOTO SUPREME 4,25-5,0

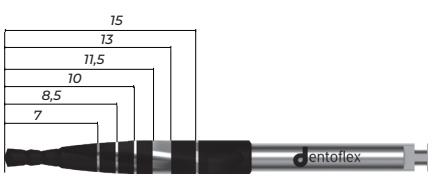
55729 

BROCA SUPREME Ø3,50

55731 

BROCA SUPREME Ø3,75

55738 

BROCA SUPREME Ø4,25

56879 

BROCA SUPREME Ø5,00

\*Imagens meramente ilustrativas. As brocas podem apresentar ou não revestimento DLC.

CHAVES

CHAVES DE CAPTURA

55834



CHAVE PARA IMPL. C.M. PARA CONTRA ÂNGULO

55851



CHAVE PARA IMPL. H.E PARA CONTRA ÂNGULO

57753



CHAVE PARA IMPL. H.I. PARA CONTRA ÂNGULO

CHAVE DE CAPTURA DE CONTRA ÂNGULO,  
TORQUE MÁXIMO 35 N.cm

CHAVES DE INSTALAÇÃO

55882



CHAVE CURTA P/ IMPL. O.C.. C.M P/ CATRACA

>> CHAVES DE INSTALAÇÃO PARA CM E HE

55883



CHAVE LONGA P/ IMPL. O.C. C.M P/ CATRACA

57755



INTERMEDIÁRIO P/ CATRACA CURTO P/ IMPL. HI

57756



INTERMEDIÁRIO P/ CATRACA LONGO P/ IMPL. HI

01379

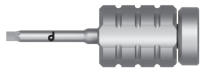

CHAVE DIGITAL HEXAGONAL MÉDIA

06821



EXTENSOR DE BROCA

INDICADORES

57750



INDICAÇÃO DE DIREÇÃO CURTO

57751



INDICADOR DE DIREÇÃO LONGO

01393

CHAVE T FIXA



55832

SONDA CALIBRADA PARA IMPLANTE

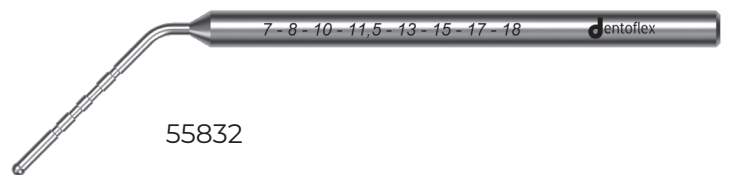

















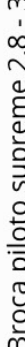



08877

CHAVE DE TORQUE

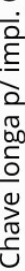
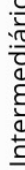

# GUIA PARA MONTAGEM

## Kit Supreme

1. Broca lança 
2. Broca lança tri-helicoidal Ø 2,3 
3. Broca supreme Ø 3,50 
4. Broca supreme Ø 3,75 
5. Broca supreme Ø 4,25 
6. Broca supreme Ø 5,00 
7. Broca piloto supreme 2,8 - 3,5 
8. Broca piloto supreme 3,0 - 3,75 
9. Broca piloto supreme 3,6 - 4,25 
10. Broca piloto supreme 4,25 - 5,0 
11. Chave p/ impl. CM p/ C.A. 
12. Chave p/ impl. HE p/ C.A. 
13. Chave p/ impl. HI p/ C.A. 
14. Chave curta p/ impl. O.C. CM p/ catraca 
15. Chave longa p/ impl. O.C. CM p/ catraca 
16. Intermediário p/ catraca curto p/ impl. HI 
17. Intermediário p/ catraca longo p/ impl. HI 
18. Chave digital hexagonal média 
19. Extensor de broca 
20. Indicador de direção curto 
21. Indicador de direção longo 

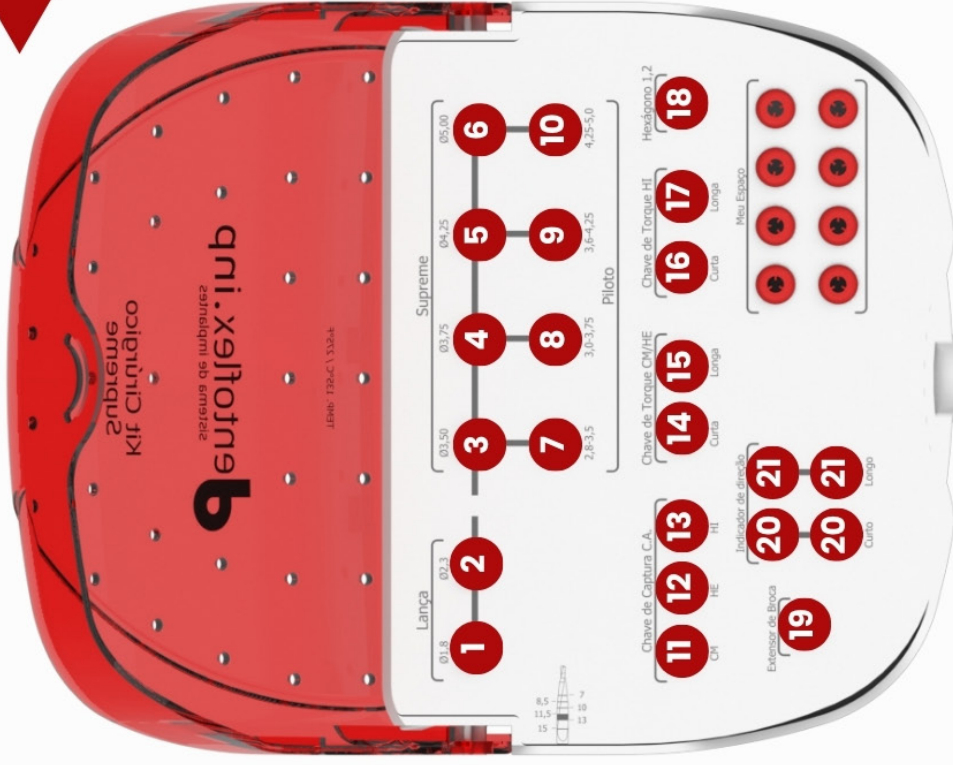

# GUIA PARA MONTAGEM

*Kit Supreme*

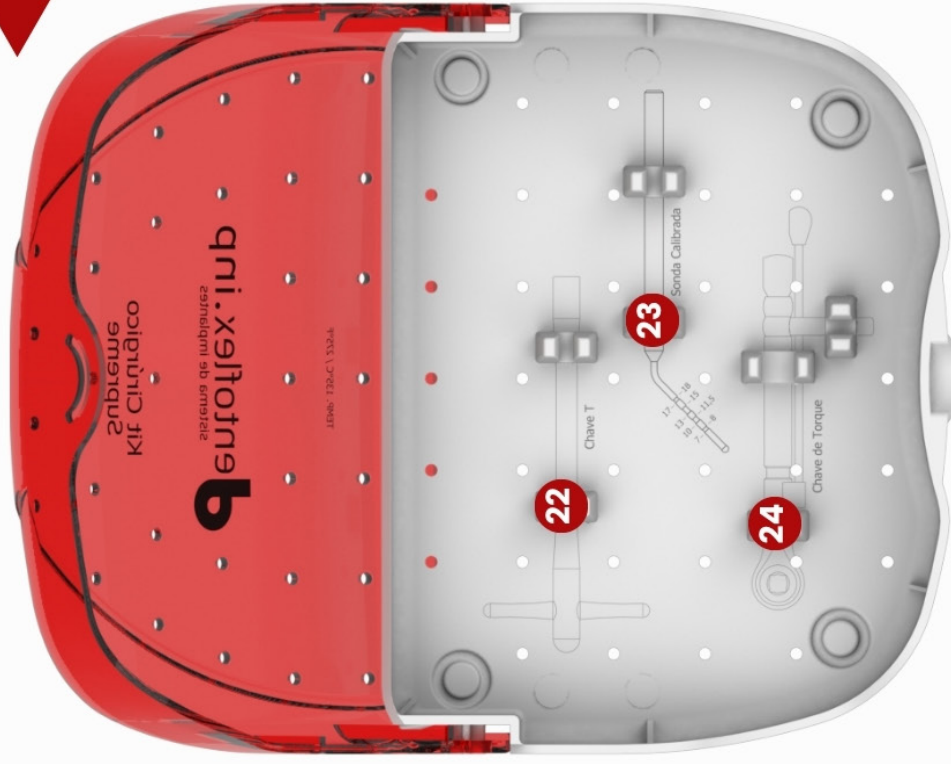

22. Chave T fixa



23. Sonda calibrada para implante



24. Chave de torque



 **dentoflex.inp**  
sistema de implantes

⊕ [dentoflex.com.br](http://dentoflex.com.br)

✉ [sac@inp-dentoflex.com](mailto:sac@inp-dentoflex.com)

☎ Tel.: 55 11 2083 - 4130

📞 WhatsApp: +55 11 99589-8239

 @DENTOFLEX.OFICIAL